

AD NO. 15850

ASTIA FILE COPY

WADC TECHNICAL REPORT 52-266

This Document
Reproduced From
Best Available Copy

ANALYSIS OF SWISS ETK TELETYPEWRITER

CHARLES P. SEYMOUR, MAJOR, USAF
LESLIE B. ROSENBERG, CAPT, USAF
WILLIAM S. DWINELL

COMMUNICATION AND NAVIGATION LABORATORY

SEPTEMBER 1957

WRIGHT AIR DEVELOPMENT CENTER

WADC TECHNICAL REPORT 52-266

ANALYSIS OF SWISS ETK TELETYPEWRITER

Charles P. Seymour, Major, USAF
Leslie B. Rosenberg, Capt, USAF
William S. Dwinell

Communication and Navigation Laboratory

September 1952

RDO No. 102-22

**Wright Air Development Center
Air Research and Development Command
United States Air Force
Wright-Patterson Air Force Base, Ohio**

FOREWORD

The work of testing and analysis of this equipment was performed under Research and Development Order No. 102-22, "Airborne Teletypewriter Equipment," by the Communications Branch, Communication and Navigation Laboratory, Directorate of Laboratories, Wright Air Development Center, Wright-Patterson Air Force Base, Ohio. Mr. William S. Dwinell served as project engineer.

ABSTRACT

Tests and analysis were made of the Swiss ETK Teletypewriter, manufactured by Dr. Edgar Gretener A. G., Zurich, Switzerland.

The sequence of operation and the functions of all component parts were determined and are described in detail in Sections III, IV, and V.

The tests and analysis were not conducted to determine what USAF use should be made of the equipment, but to present the principle of operation.

PUBLICATION REVIEW

This report has been reviewed and is approved.

FOR THE COMMANDING GENERAL:



for CHARLES U. BROMBACH
Colonel, USAF
Chief, Comm and Nav Laboratory
Directorate of Laboratories

TABLE OF CONTENTS

	Page
	Introduction----- vi
Section I	General Description----- 1
Section II	Sequence of Operation----- 3
Section III	Function of Teletypewriter Parts----- 5
Section IV	Operation of Line Unit-----15
Appendix I	Parts List ETK Teletypewriter-----20
Appendix II	Parts List Control Panel ETK TT-----22
	Distribution List-----24

LIST OF ILLUSTRATIONS

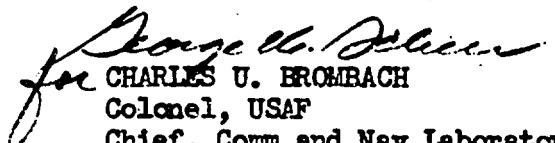
Figure		Page
1	Swiss ETK Teletypewriter -----	vii
2	Swiss ETK Terminal Unit -----	viii
3	Swiss ETK Teletypewriter, Cover Removed -----	ix
4	Keyboard Section, Bottom View -----	5
5	Keyboard Contacts and Transmitting Commutator -----	6
6	Control Relays -----	7
7	Electrical Circuit, Receiving -----	9
8	Receiving and Transmitting Mechanism -----	10
9	Type Wheel-----	11
10	Interior View -----	12
11	Motor Governor -----	13
12	Terminal Unit -----	14
13	Schematic Diagram -----	17
14	Filament Wiring -----	18
15	Coding Table -----	19

INTRODUCTION

Various methods have been under commercial investigation for the incorporation of error indication provisions in teletypewriter systems. One approach to this problem is through the use of an elemental printing technique. In this system, a character is composed of a combination of marking bits, each bit being the result of a finite electrical signal. Consequently, disturbance of any individual signal will result in the addition or deletion of one marking bit. This results in either a mutilated or an incomplete character, thus accomplishing the error indication.

One equipment utilizing the elemental printing method is the Swiss ETK Printer, developed and manufactured by Dr. Edgar Gretener A. G. of Zurich, Switzerland. Three machines were obtained on or about 1 June 1951 by Wright Air Development Center, from that source with the assistance of the USAF Intelligence Department and U. S. foreign legation at Bern, Switzerland.

Prior to this time, proprietary rights restricted dissemination of the detailed operational description of this machine. However, upon receipt of permission to release this information, a detailed study was made of the printer functions, component parts and their use in the sequence of operations. This information is herein presented inasmuch as it is not detailed in the Handbook of Operating Instructions.

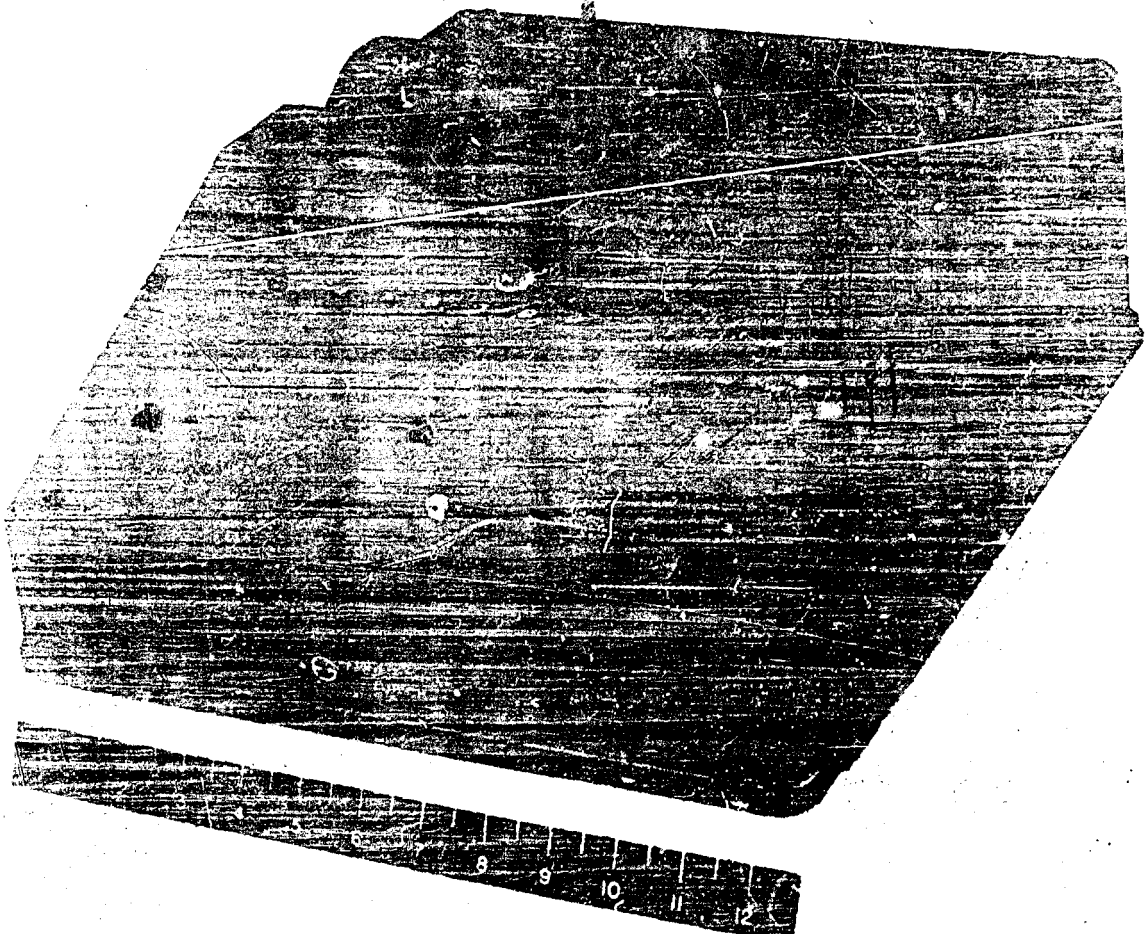

FIGURE 1
SWISS ETK TELETYPEWRITER

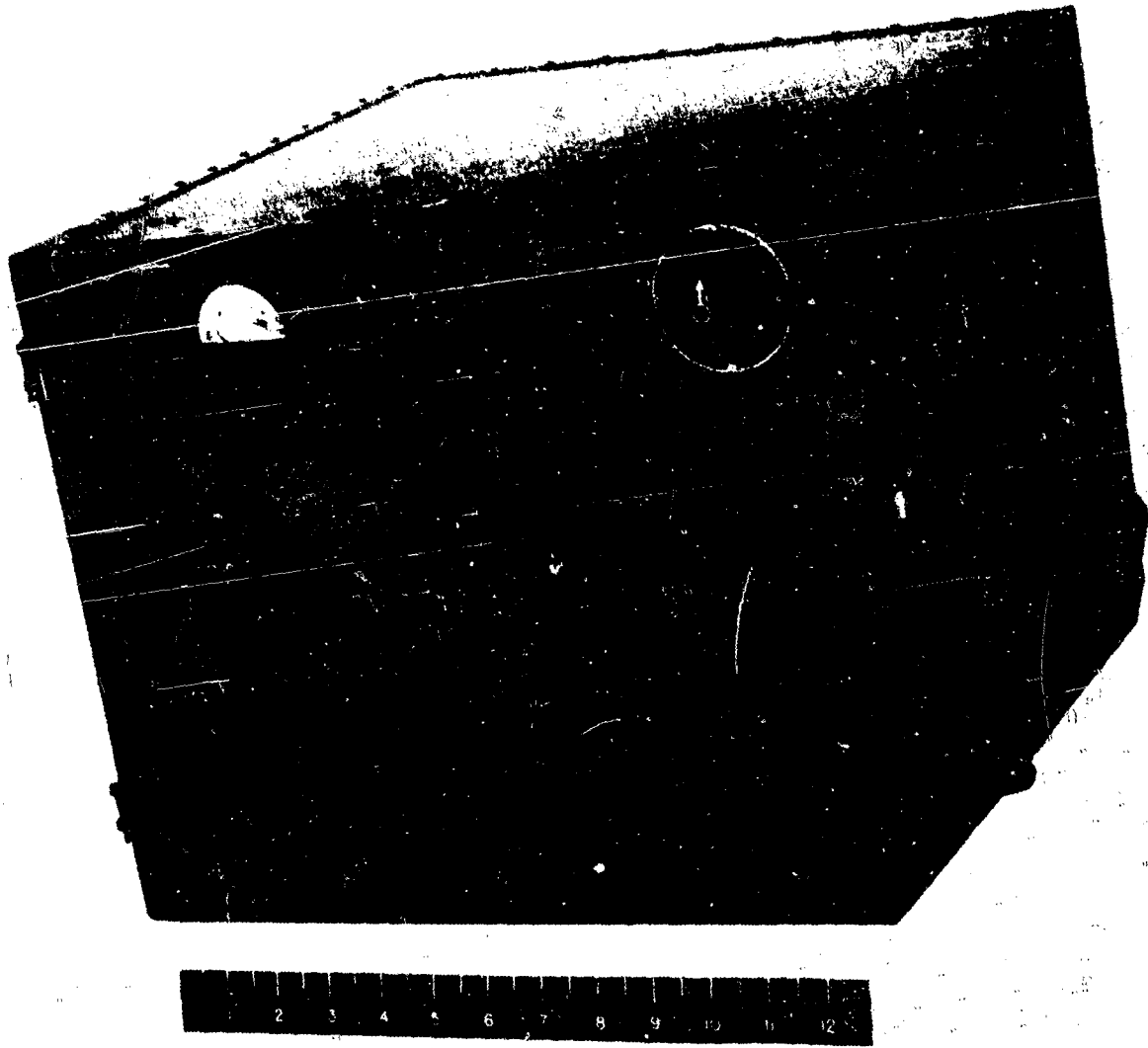

FIGURE 2
SWISS ETK TERMINAL UNIT AND TELETYPEWRITER CARRYING CASE

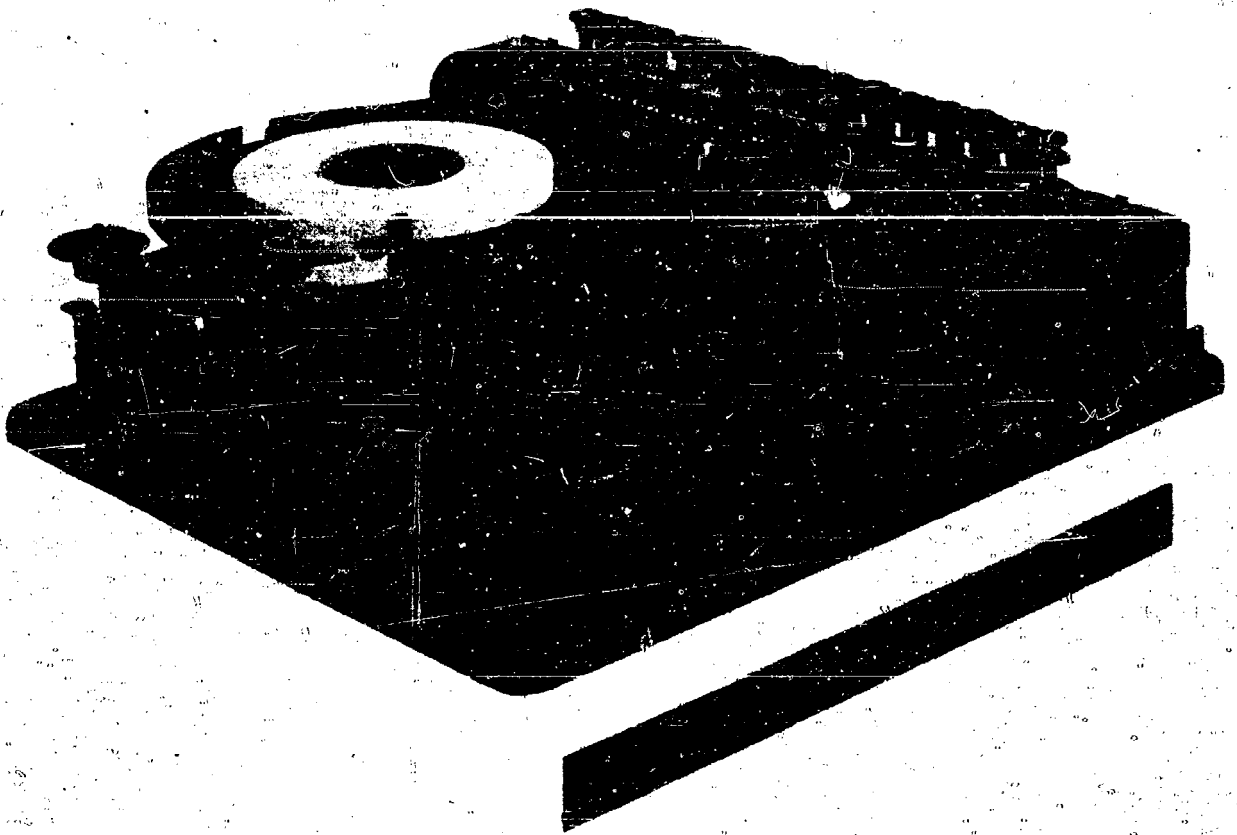

FIGURE 3
SWISS ETK TELETYPEWRITER, COVER REMOVED

SECTION I GENERAL DESCRIPTION

1. General Information:

The Swiss ETK Teletypewriter is an elemental printing machine, operating on the asynchronous "start-stop" principle. It utilizes a conventional electro-mechanical printing control system. Unique, however, is the method of character printing. The character is formulated by the printing of a combination of 14 sign elements, of which a maximum of 5 impressions are required for printing any complete character. The character, composed of the appropriately selected elements, is printed during one revolution of the type wheel. Rotational torque impressed on the type wheel and the other component element is supplied through the use of a 12 volt governed motor.

The apparatus is stored in an aluminum carrying case 18-1/4" x 13-3/4" x 11-1/2", weight of which when loaded is 56 lbs. This case contains the ETK teletypewriter, amplifier, four connecting cables and a box of spare parts.

Operation may be accomplished from a prime power supply of either 110 or 245 volts AC or 12 volts DC. The equipment may be used either on land lines or in conjunction with a radio-telephone circuit directly, as output from the set is in the form of an audio tone.

2. Component Parts:

The Swiss elemental printer consists of a transmitting keyboard, typing unit, base and cover. The motor is mounted on the base perpendicular to the typing unit. A tape reel is located on the base behind the motor.

The typing unit consists of the selecting, printing and associated functional mechanisms.

3. General Operation:

The keyboard section transmits signal combinations of the start-stop 14 unit code to the selecting mechanisms of all interconnected typing units via the associated terminal unit.

In order to maintain synchronization between transmitting and receiving units, each group of selected intervals is preceded by a start interval and followed by a stop interval.

A holding magnet, located on the typing unit, responds to the start and stop intervals for synchronizing the receiving machine with the transmitting unit. A cam-operated contact switches the receiving circuit from the holding magnet to the selector magnet after the start interval is received, and back to the holding magnet when the stop interval is received.

The type stamps are mounted on the type wheel which, for every transmitted letter, executes one revolution. As the type wheel rotates, a spring loaded printing hammer, which is held in the cocked position by the selector magnet, strikes the proper type stamp when a "no current condition" exists at the selector magnet. The elements are printed simultaneously with the reception of the impulses.

Rest condition of the system, during which time an action arresting or holding magnet is energized, results from open keyboard contacts. Closure of the keyboard contacts, with subsequent transmission of the information via the transmitting commutator, actuates the receiving magnet by signal reversal through the associated terminal unit. Detailed explanation of this is made in Section II.

SECTION II SEQUENCE OF OPERATION

In order to understand the detailed functions of the individual component parts, familiarity with the over-all sequence of operations is desirable. Following, in sequential operations, is a presentation of the transmission and ultimate printing of the letter "H".

- (1) "H" key lever is depressed.
- (2) Keyboard transmitting switches numbers 0, 1, 4 and 5 close.
- (3) Keyboard locking lever holds "H" key lever locked, and prevents depressing additional key.
- (4) Closing of switch 0 (designated start switch) actuates control relay 0.
- (5) Closing of control relay 0 furnishes operating voltage to commutator segments number 0, 1, 4 and 5.
- (6) Voltage present on segment 0 is transferred via the brushes and interconnecting line to the line unit, and the screen grid of the combination gate and oscillator tube.
- (7) The tone start pulse is carried through the line unit and results in a current drop through the drive shaft arresting magnet.
- (8) The arresting magnet is de-energized, releasing the drive shaft and permitting its rotation.
- (9) The magnet transfer switch, actuated by a cam on the drive shaft, switches the receive circuit from the drive shaft arresting magnet to the element selecting magnet.
- (10) Concurrently, separate switch contacts on the magnet transfer switch, re-energizes the drive shaft arresting magnet. However, a magnet arresting cam prevents the arresting of the drive shaft.
- (11) The transmitting brush contacts commutator segment number 1 and transmits the signal pulse to the line unit.
- (12) Character pulse number 1 de-energizes the element selecting magnet and permits the printing hammer to strike number 1 element of the element head, thus printing the element "1".
- (13) The control relay switch, located adjacent to the magnet transfer switch, and similarly actuated by a cam on the drive shaft, de-energizes the control relay.

- (14) The transmitting brush contacts (in sequence) segments number 2 and 3. As no voltage exists on these contacts, the gate-oscillator tube is non-conductive, current flows through the element selector magnet and the printing hammer is retained in the cocked position.
- (15) Character pulses numbers 4 and 5 are transmitted to the element selecting magnet as described in operation 11 and 12, thus printing the elements "-" and "1". The combination of the three elements printed thus compose the letter "H".
- (16) The drive shaft completes its rotation, and since no other commutator segment is energized, the printing hammer is retained in the cocked position throughout this interval.
- (17) The keyboard locking lever is released, thus releasing the depressed key.
- (18) The holding magnet and resting cam permits the holding magnet to arrest the drive shaft.
- (19) The magnet transfer and relay transfer switches return to the rest position reset for initiation of another operation.

SECTION III
FUNCTION OF TELETYPEWRITER PARTS

1. Keyboard:

a. Pressure on a key or space bar causes the associated key lever to strike the edges of a selector bar, which in turn sets up the key switch combination for the desired character. The key levers have extrusions arranged in a coded sequence so as to strike the proper selector bars. The selector bars are pivoted at the end in such a manner that pressure on them from the key levers causes them to swing down, actuating an eccentric arm. A double throw single pole switch is attached at the end of each selector bar, and the motion of the eccentric arm actuates the key switch.

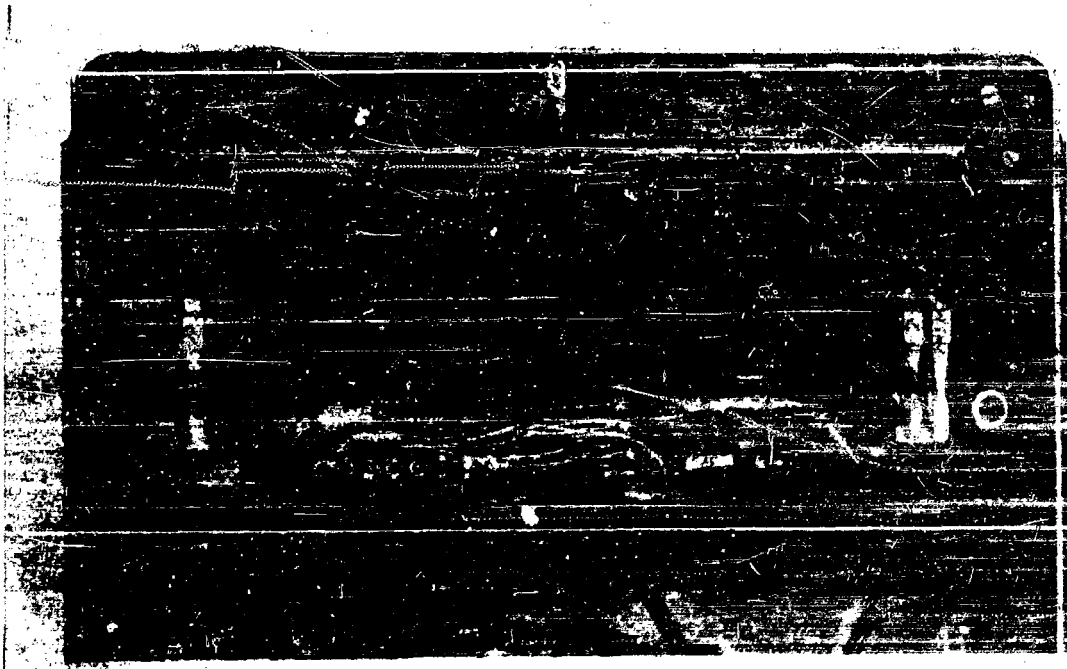

FIGURE 4

Bottom View of Keyboard Section (Cover Removed)
Showing Key Levers and Selector Bars

b. Switch #0, located on the upper left side of the keyboard, is closed when any key is depressed. Switch #0 is referred to as the starting switch. SYN, WERDA and WR keys close only switch #0.

c. In order to prevent errors in signal sequence, caused by too rapid depression of typing keys, a locking device is incorporated. The locking bar is moved into place mechanically preventing the depression of another key until one complete revolution of the type printing mechanism has been completed. To prevent repetitive printing of one character when a key is held down, a displacement arm releases switch #0 necessitating a complete cycle to be reinitiated.

d. Repetition of transmission is effected by the repeat (SYN) key. This key is self-locking. Depression of the SYN key holds the locking bar back and prevents the transmit switch from being locked for one cycle only. To continuously print a character, the desired key and SYN key are both depressed and the character key held.

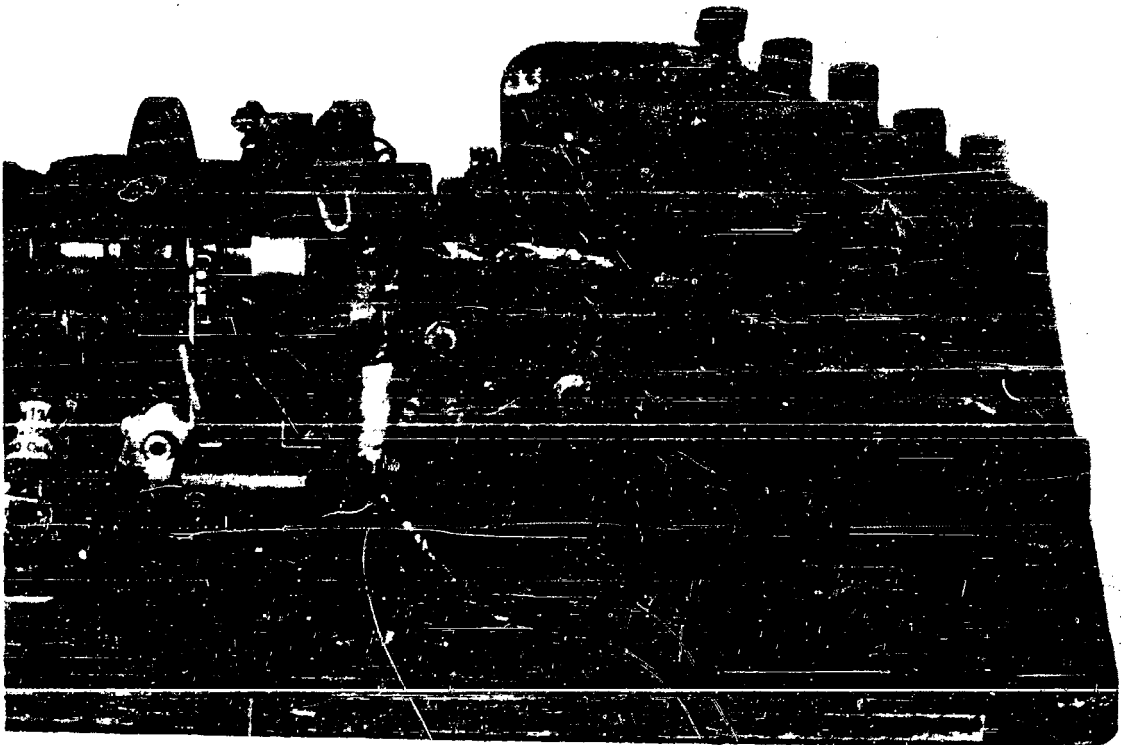

FIGURE 5

Keyboard Contacts and Transmitting Commutator

e. The depression of a key closes the proper switch contact and completes the circuit from lines 22 to 24 for switch #0, and from lines 16 to 22 for switches #1-14. The function of switch #0 is to provide a starting signal to be fed to the control unit through line 24. The closing of any key switch other than #0 places 10 volts potential on the associated segment of the transmitting commutator (Figure 7, No. 4). Subsequently, as the brush (Figure 7, No. 5 rotates along the segments it will pass the voltage pulses to the control unit through line 16.

2. Relay "0":

a. Relay "0", the start relay, is located at the rear right hand side of the base. (Figure 6, No. 2).



FIGURE 6
CONTROL RELAYS

b. The purpose of relay "O" is to provide a voltage to segment #0 of the commutator which provides the following functions:

- (1) Provide synchronizing signal.
- (2) Provide starting signal that releases the drive shaft arresting magnet "5", and permits the printing shaft to rotate.

c. Three wires are attached to the base of the relay. Brown-green to switch 8 (n2), red-white to typing speed control and red-blue to switch 8 (n2 and n3). Two wires are attached to the switch of this relay; red from power supply to segment #0 and green-yellow to ground.

d. Complete time sequence of operation of relay "O" in conjunction with the brush and relay "5" was covered in Section II.

3. Relay "C":

a. Relay "C", is located next to and in front of Relay "O". (Figure 6, No. 3).

b. The purpose of this relay is to provide a constant voltage to the commutator brushes so that all elements will be printed during a printing cycle. The "WERDA" key, when depressed, closes Switch #0, and in addition completes the circuit from line 23, through relay "C", to line 5.

c. Two wires are attached to the switch of this relay: Red-gold to the brush and green-yellow to ground.

4. Switch 8:

a. Switch 8 (Figure 7) actually consists of two separate switches. The front switch (n2) (Figure 7, No. 7) has two arms; the bottom red-green lead and top green-brown form a series circuit with relay "O". The rear switch (n3) (Figure 7, No. 6) has five arms with the top and bottom arms wired together. The bottom arm, number 1, has its red-blue lead connected to relay "O", "C2", and "5". Number 2, a blue-white wire has 35 volts potential with respect to ground. Number 3 arm is connected to relay "6" through the red-gray lead and number 4, green-yellow, is ground return.

b. In rest position (no key depressed), n2 is closed and arms 1 and 2 of n3 are in contact. N2's function is to provide 35 volts direct current to one side of relay "5".

c. In the running position, n2 opens relay "O" circuit ~~de-energizing~~ this relay. Arm 2 of n3 is connected to arm 3 providing current to relay 6. Arms 4 and 5 are connected switching relay "5" from lines 22 to 18 to lines 20 to 22.

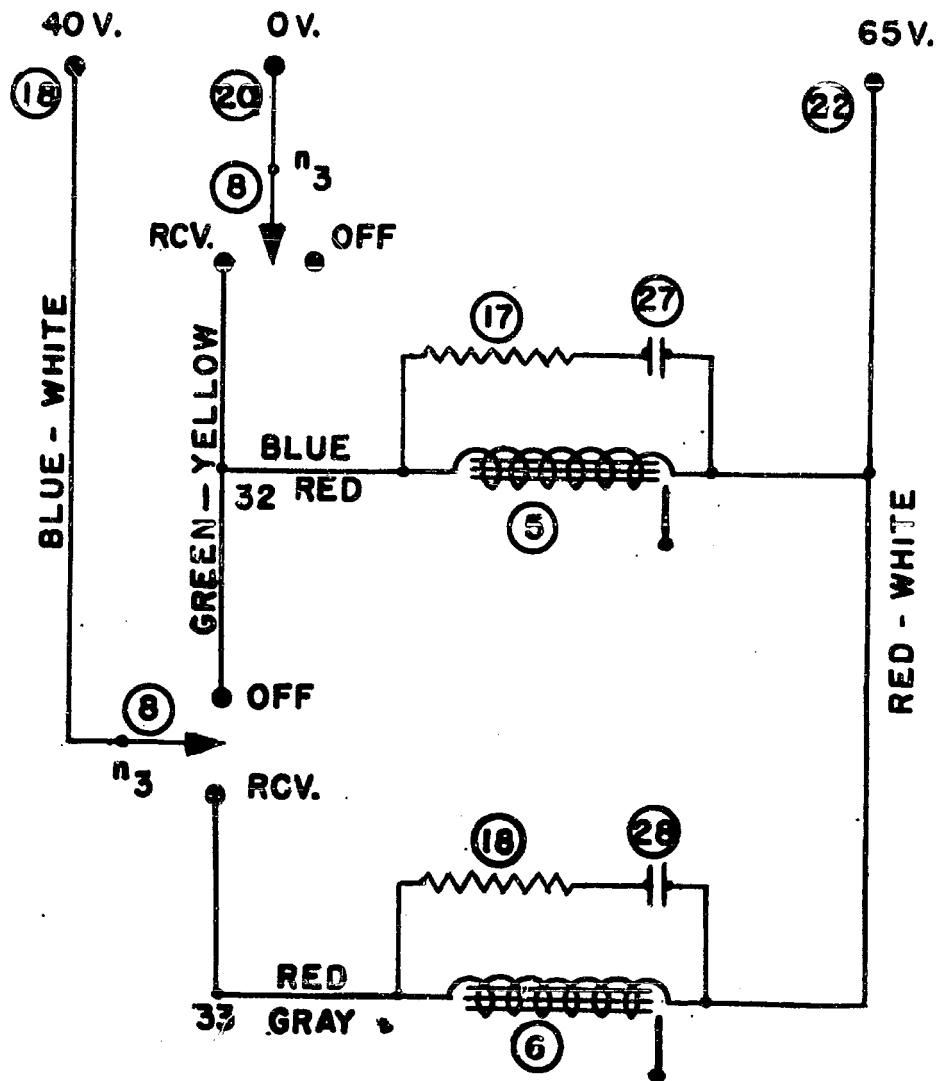

FIGURE 7
ELECTRICAL CIRCUIT, RECEIVING

d. Switches n2 and n3 are mechanically moved by the rotation of two cams on the drive shaft. N3 is the first to be switched from rest to running with n2 opening a very short period later. This time differential insures that segment #0 will have voltage applied to it during the entire sweep of the brush, and that relay "0" will definitely be deenergized before the next cycles is to start. (Without n2, the shaft will go through two cycles instead of one).

5. Relay "5":

a. Relay "5", Drive Shaft arresting Magnet, is located on the left hand side of the printing drive shaft and in front of the printing drum (Figure 3, No. 2). Its purpose is to hold the drive shaft from rotating during the rest period, and release it for printing during the operating period.

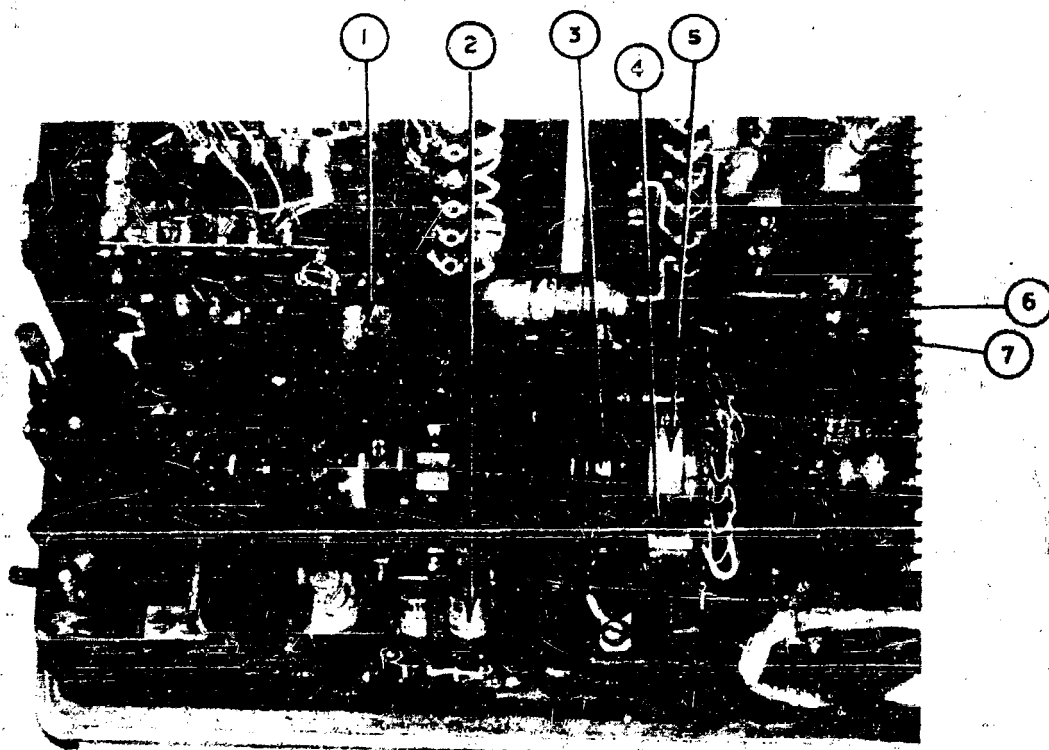

FIGURE 8

RECEIVING AND TRANSMITTING MECHANISM

b. During the rest period, relay "5" is energized. When closed, the engaging arm contacts the arresting arm on the drive shaft preventing the shaft from turning. When deenergized, a spring pulls the engaging arm upward so that it no longer contacts the arresting arm.

c. During the rest period, this relay inter-connects line 18 and line 22. Line 18 is connected to the output of the control unit and line 22 connects with B plus (65 volts). During no signal, a potential of 25 volts exists across the relay. During transmission of the start pulse, there exists zero potential across the relay and it will deenergize, allowing the drive shaft to rotate.

d. During rotation, switch 8 has switched the relay from line 18 to grounded line 20. Sixty-five volts then exist on the relay, energizing it so that it tries to stop the shaft from rotation, but a cam on the drive shaft keeps the bar on the relay from reaching the shaft until the cycle is completed. Switch 8 then replaces line 20 with line 18 and the relay again stops the shaft from rotating.

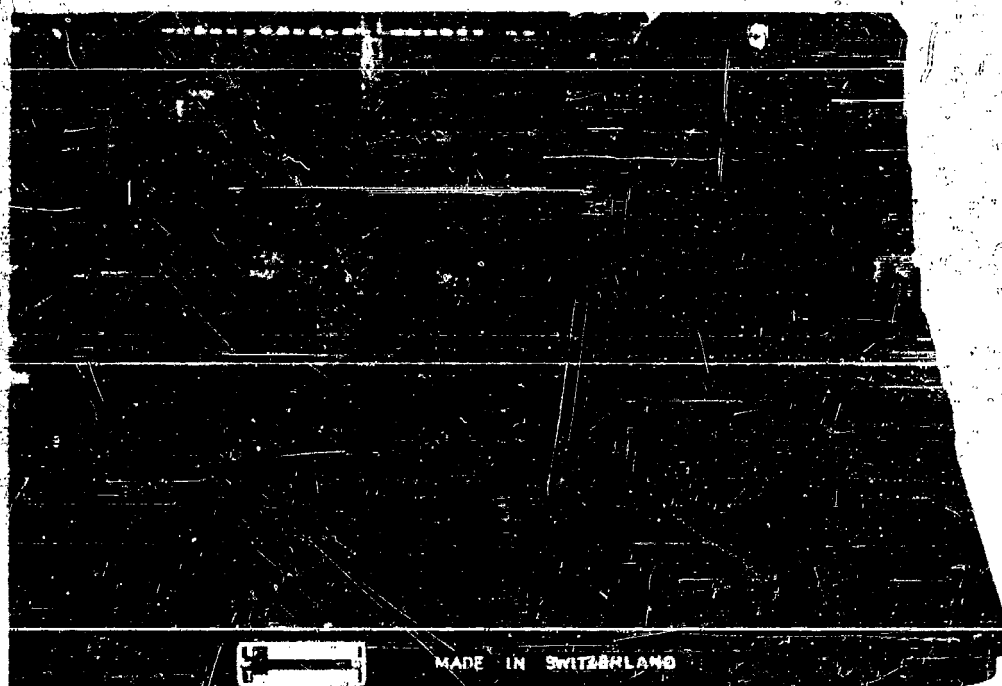

FIGURE 9

Type Wheel

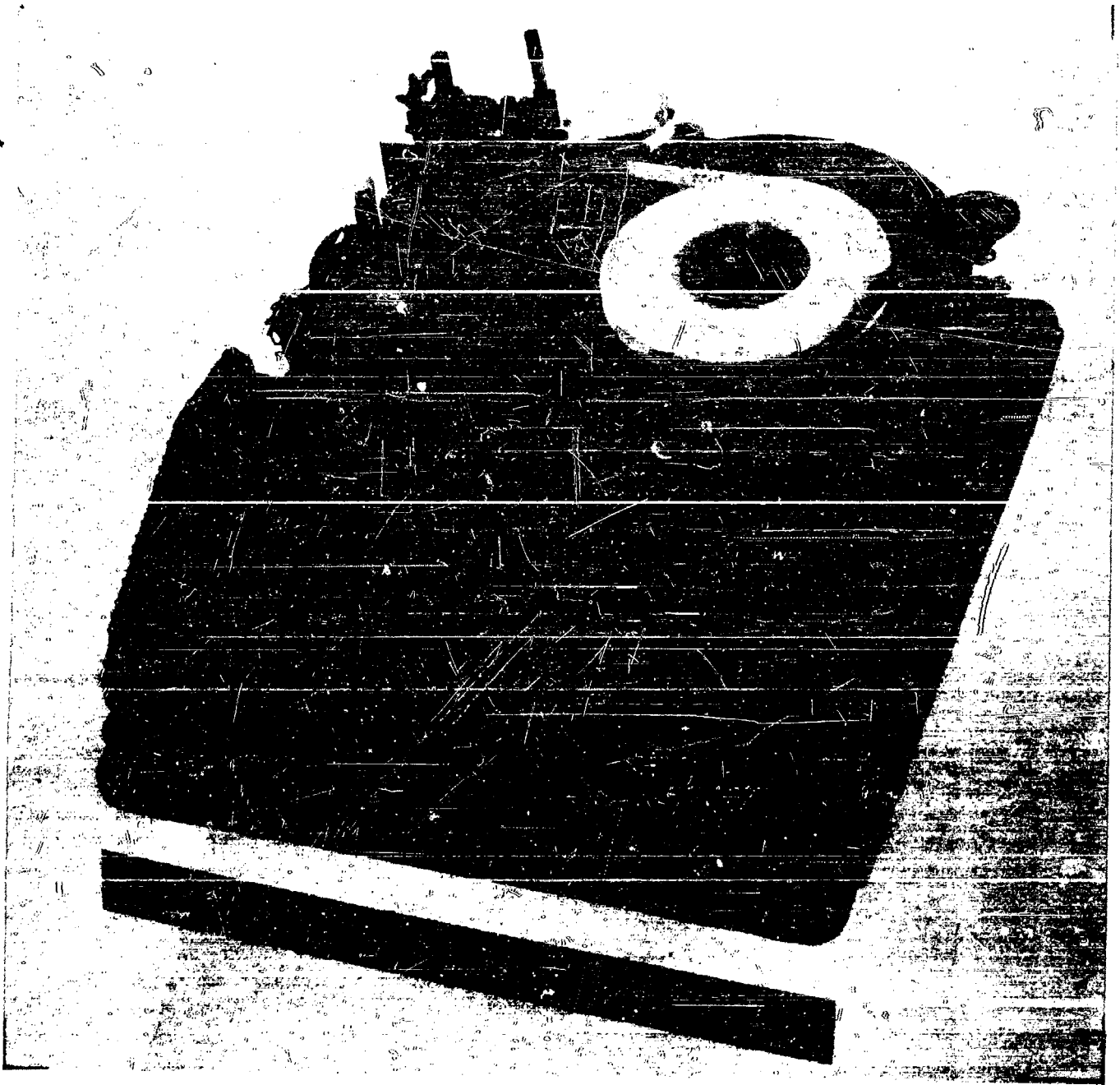

FIGURE 10
INTERIOR VIEW



FIGURE 10
INTERIOR VIEW

9. Motor:

a. The motor is a 12 volt direct current shunt motor. A centrifugal switch governor (No. 2 and 3; figure 10) is incorporated in the armature circuit. This switches the speed control resistor into the circuit (No. 1, Figure 11).

10. Typing Speed Control:

The typing speed control is located in the far right corner of the base (No. 1, Figure 6) and is a potentiometer in series with relay "C". Its purpose seems to be that of governing the speed of the typist. This resistor acts in conjunction with relay "O" as a delay time for initiation of the start pulse, thus effectively reducing the typing rate of the equipment.



FIGURE 11

Motor Governor

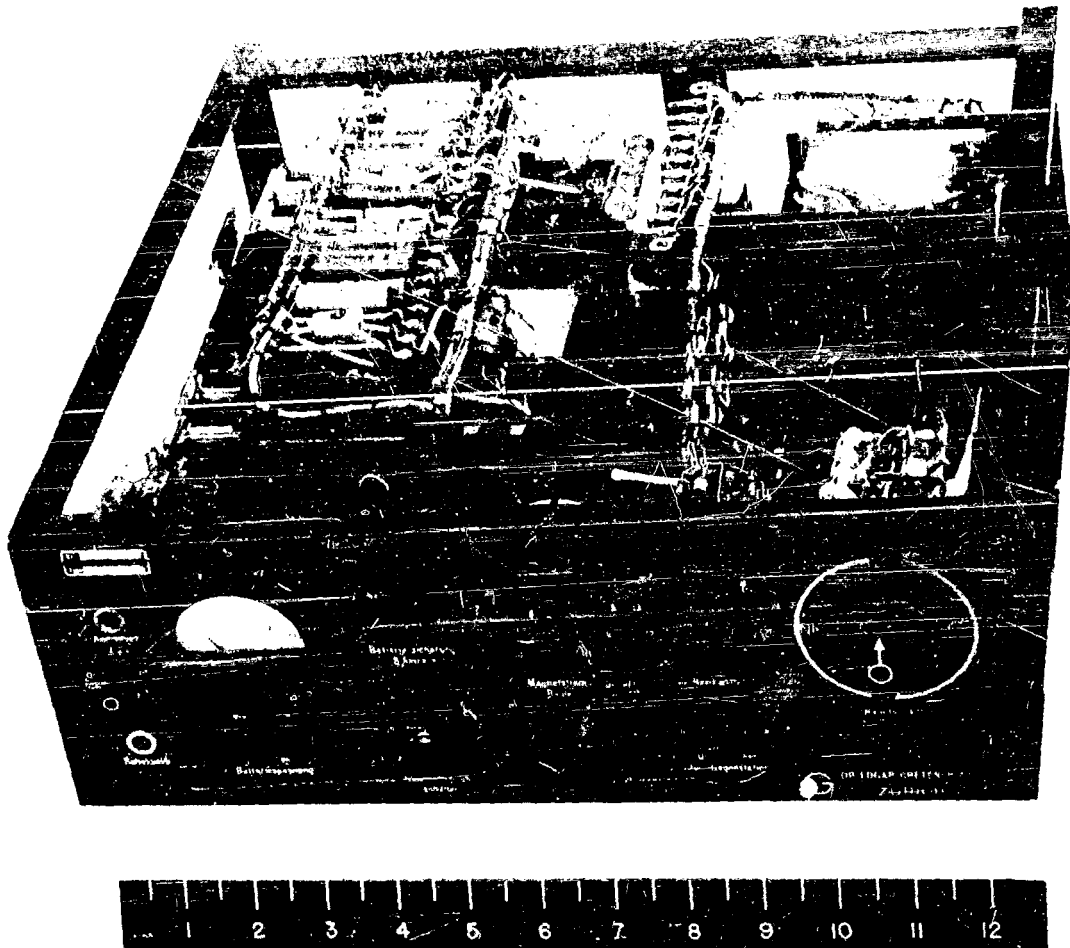

FIGURE 12
TERMINAL UNIT

SECTION IV OPERATION OF LINE UNIT

With reference to Figures 13 & 14, following is a description of the operation of the line unit of the Swiss ETK Teletypewriter. This unit is a necessary part of the set, the printing mechanism being incapable of operation without it or a similar piece of equipment.

1. Input From Distant Station.

a. The incoming tone signals are introduced to the line unit through Jack No. 77-(ANSCHLUSS) and the input low-pass filter, thence transformer coupled to the amplifier stage.

b. From the input transformer, the signal passes through the Range Control (Reichweite) and is condenser coupled to the control grid of the amplifier. The Range Control is utilized to balance the gain of the amplifier with the line losses. Range of this control is from 10 to 40 db in steps of 3 db.

c. The tone amplifier portion of tube 11 amplifies the incoming tone, and is transformer coupled to tube 12 through the tone filter network composed of resistors 24 and 25 in combination with condensers 48 and 49. The output of the filter is direct coupled to the grid of tube 12 through resistor 27.

d. Output of tube 12, plates of which are in parallel, operates the selector magnet in accordance with the tone signals appearing on the grid. Voltage of the plates of the tube varies from a nominal 65 volts for no tone (mark) and 35 volts for tone (space).

2. Input from Local Station.

a. Signals from the local printer, consisting of DC on-off pulses are fed to the Line Unit via conductors numbered 24 & 16. Transfer of signals between the two is accomplished by Switch 8, No. 24 conducting the start signal and No. 16 the character pulses. The pulses appear at the screen grid of Tube No. 10 (Oscillator-Gate) as voltage developed across Resistor 18.

b. The gate portion of Tube No. 10 is biased so as to conduct only when the positive voltage developed across Resistor 18 appears on the screen grid.

c. In addition, the oscillator portion of tube 10 oscillates with the appearance of the voltage developed across Resistor 18 on the screen grid. Condenser No. 44 and the primary of Transformer No. 5 form the LC parallel resonant circuit with condenser No. 46 providing feedback to Tube No. 10. The 1500 cps frequency is coupled to the grid of the Gate portion of Tube 10 through condenser No. 45 from the secondary of Transformer No. 5.

d. Output of the Gate of Tube 10 is fed both to the outgoing line and also back into the Line Unit for monitoring purposes. Actuation of the local printer is accomplished in a manner similar to an incoming line signal. An additional

function performed by Tube No. 11 is that in conjunction with resistors 19, 17 and 21 of the filament circuit, an AVC voltage is developed to control output of the gate portion of tube No. 10.

e. For origination of a break signal, Line Breaking Switch No. 69 is connected in such a manner as to furnish a positive voltage to the screen grid of Tube No. 10. This causes a constant tone to be transmitted to the local and distant printers causing these machines to print continuously.

3. Operational Controls:

a. Line Unit Front Panel.

- (1) Anschluss ATF. Terminal Jack for line connection.
- (2) Ruheklinke. Dead Jack.
- (3) Magnetstrom. Reads current into Relay 6 or battery voltage.
- (4) Drucken Batteries Pannung. Press this button to read battery voltage on Magnetstrom.
- (5) Batterie-Sicherung. 8 amp. battery fuse.
- (6) Netzspannungs-schalter. Line voltage selector. 1 amp fuse.
- (7) Magnetstrom-Regler. Current regulator for Relay 6.
- (8) Reichweite. Range Control.
- (9) Unterbrecher fur Gegenstation. Line break switch.
- (10) Hauptzhalter. Power Selector Switch.
 - (a) Netz. A.C. power source.
 - (b) Aus. Off
 - (c) Batt. Battery

b. Line Unit. Terminal Panel:

- (1) HF-App. Radio Input
- (2) Batterie. Battery Input
- (3) Maschine. Primary Printer connection.
- (4) Netz. A.C. power input.

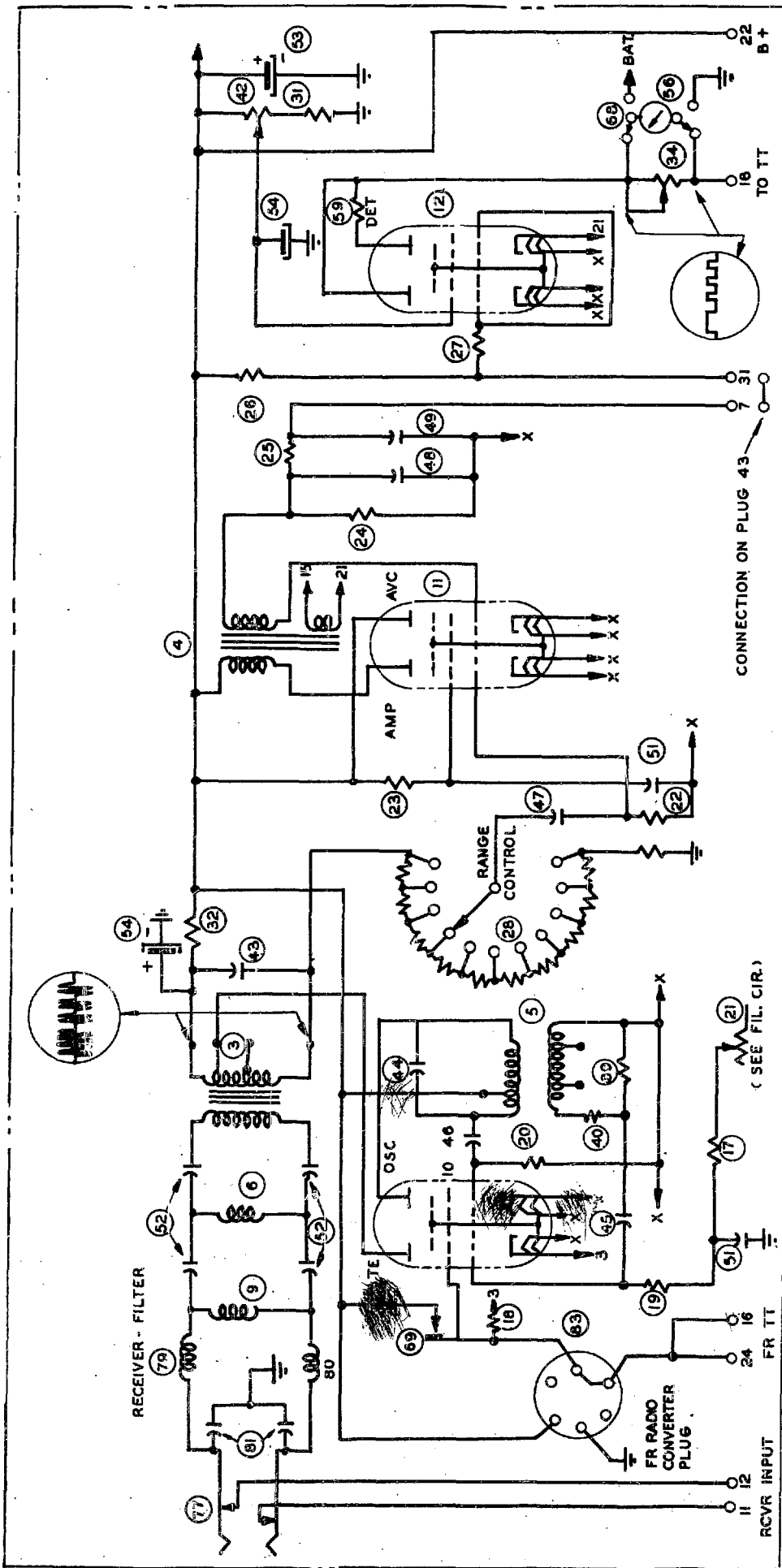

FIGURE 13
SCHEMATIC DIAGRAM

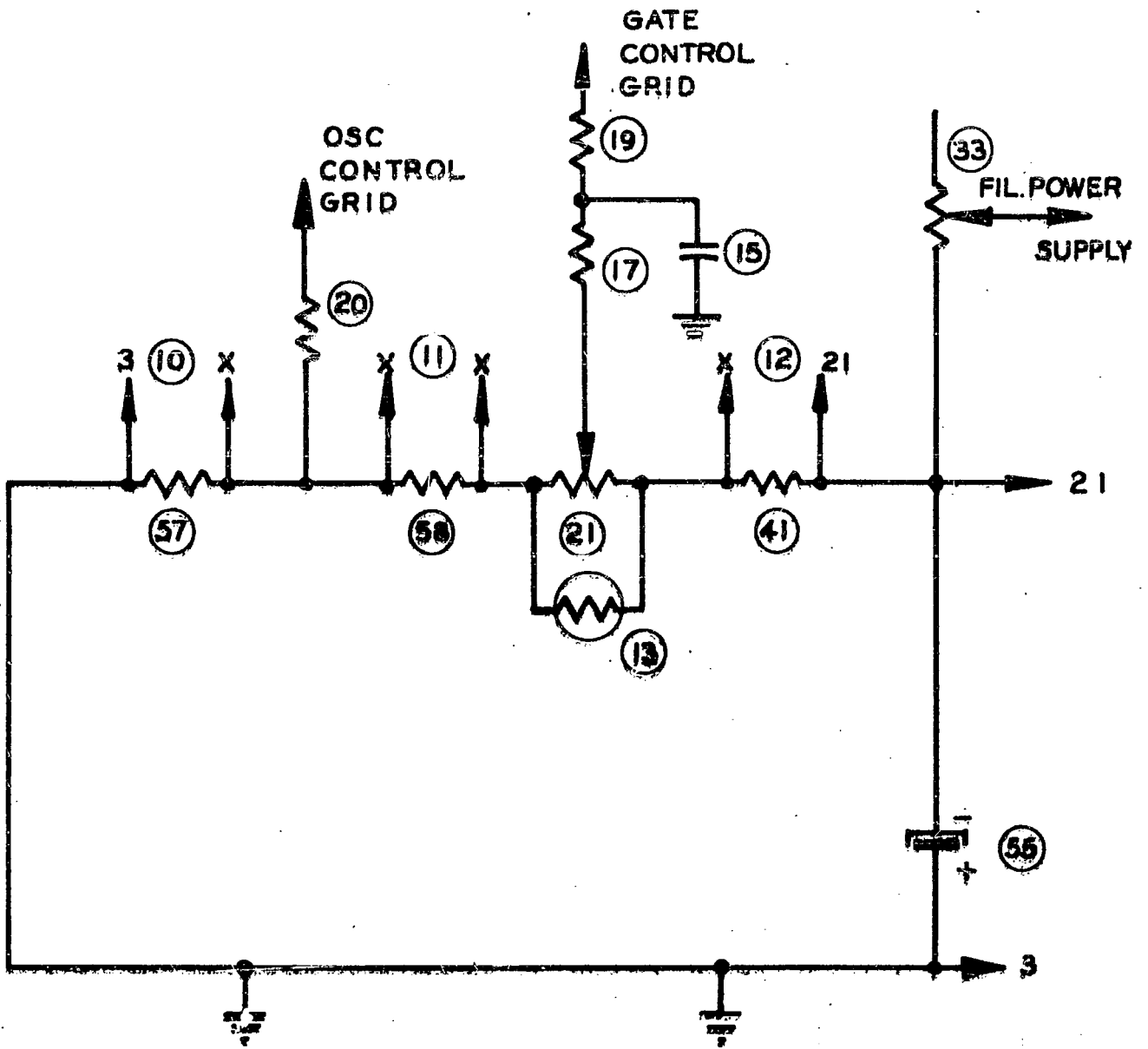

FIGURE 14
FILAMENT WIRING

	1	2	3	4	5	6	7	8	9	10	11	12	13	14
A	•	•	•	•	•									
B		•	•	•						•		•		
C	•	•	•											
D		•	•	•						•				
E	•	•	•		•									
F	•	•			•									
G	•	•	•									•		
H	•			•	•									
I										•				
J		•	•	•					•					
K	•					•	•		•					
L	•		•											
M	•			•		•					•			
N	•			•			•				•			
O	•	•	•	•										
P	•	•				•		•						
Q	•	•	•	•			•							
R	•	•				•	•	•						
S		•	•					•				•		
T		•								•				
U	•		•	•										
V	•					•			•					
W	•			•			•		•			•		
X						•	•		•			•		
Y						•			•			•		
Z		•	•			•			•					
1				•		•								
2		•	•			•		•	•					
3		•	•			•						•		
4				•				•		•				
5		•						•	•					
6	•	•	•		•							•		
7		•				•			•					
8		•	•	•	•			•						•
9					•					•				
+					•					•				
-					•									
<						•	•							
>									•		•			
/						•			•					
?		•				•							•	
'									•					
.													•	
=			•		•									

KZ: 5 Drähte nach Bedarf (5 WIRES WHEN OR IF NEEDED)
 Bedarf: Verdrahtung nach Maschinenschema

(WIRING PER DRAWING OF MACHINE) (AS FAR VERDRÄHTUNG SOWEIT AS TZ IS PROVIDED) gemäss TZ vorgesehen

ETK-Schreiber Sicherheitsalphabet

FIGURE 15
CODING TABLE

APPENDIX I

PARTS LIST, ETK TELETYPEWRITER

1. No Assignment
2. Motor and Dynamotor
3. Governor
4. No Assignment
5. Clutch Release Relay
6. Printing Character Release Relay
7. No Assignment
8. Keyboard Intelligence Switch
9. Commutator
10. No Assignment
11. No Assignment
12. End of Paper Switch
13. Relay "O"
14. Relay "C" (Used with Werda Key)
15. Light Socket (Reading Tape)
16. Light Socket (End of tape indication)
17. Resistor, 1000 ohm, shunt relay 5.
18. Resistor, 1000 ohm, shunt relay 6.
19. No Assignment
20. No Assignment
21. Slide Wire Resistor, Series with motor.
22. Resistor, Series with motor.
23. Resistor, 35 ohm, Fixed resistor in Printing speed control
24. Resistor, 30 ohm, Tape Printing Light Circuit
25. Resistor, 30 ohm, End of Tape Circuit.
26. Resistor, 300 ohm, Shunt, Werda Relay "C".
27. Condenser, .1 ufd, Shunt, Relay 5.
28. Condenser, .1 ufd, Shunt Relay 6.
29. Condenser, .01 ufd, By pass to ground.
30. Condenser, .1 ufd, By pass to ground.
31. Condenser, .1 ufd, By pass to ground.
32. Condenser, .2 ufd, By pass to ground.
33. Condenser, 1.0 ufd, By pass to ground.

34. Condenser, 1.0 ufd, Motor shunt
35. Condenser, 2.0 ufd, Motor circuit.
36. Condenser, 50 ufd, Ground return with Syn. switch depressed.
37. No assignment.
38. Choke, Motor Circuit, Filter.
39. Choke, Motor Circuit, filter.
40. Choke, Motor Circuit, filter
41. No assignment.
42. Battery-Line Switch.
43. Input plug.
44. Potentiometer, Speed Control of Printer.
45. Resistor, 500 ohms, Syn. Shunt
46. Resistor, Series with Syn. Key.
47. No assignment.
48. Switches 0 through 14.
49. Bar.
50. Resistor, series with light.
51. Condensers (2), Counter Circuit
52. Counter Relay

APPENDIX II

PARTS LIST- CONTROL PANEL ETK TT

- | | |
|---|---|
| 1. No assignment | 33. Resistor, 28 ohms, Filament Voltage. |
| 2. Transformer, Main power | 34. Resistor, 100 ohm, meter shunt. |
| 3. Transformer, Input, Line Filter Coupling. | 35. No Assignment |
| 4. Transformer, Amp-Limiter Coupling. | 36. Resistor, 5000 ohm, Ammeter ckt as voltage drop. |
| 5. Transformer, Oscillator | 37. Resistor, 2000 ohm, Current limiter for Switch #8. |
| 6. Choke, Line Filter | 38. No Assignment. |
| 7. Choke, B plus | 39. Resistor, 3000 ohm, Secondary |
| 8. No Assignment | 40. Resistor, 2000 ohm, Secondary |
| 9. Choke, Line Filter | 41. Resistor, 50 ohm, filament. |
| 10. Tube, Philips Type DLL21 | 42. Resistor, 5000 ohm, B plus. |
| 11. Tube, Philips, Type DLL21 | 43. Condenser, Transformer #3 Shunt, 450 uf. |
| 12. Tube, Philips, Type DLL21 | 44. Condenser, 500 mfd, RL Osc. |
| 13. Bias Resistor Shunt | 45. Condenser, .005 mfd, Amp Control grid by-pass. |
| 14. Selenium Rectifier | 46. Condenser, .001 mfd osc. Feed-back. |
| 15. Selenium Rectifier | 47. Condenser, .0012 mfd Control Grid, Amp. |
| 16. No Assignment. | 48. Condenser, .0035 mfd Filter |
| 17. Resistor, 0.02 ohms. | 49. Condenser, .0025 mfd, Filter |
| 18. Resistor, 8000 ohm, Gate Screen Grid bias. | 50. No Assignment. |
| 19. Resistor, .5 ohms. | 51. Condenser, .5 ufd ground by-pass for gate control grid. |
| 20. Resistor, .1 ohm. | 52. Condenser, (4), Line Filter, .25 ufd |
| 21. Variable Resistor, 1000 ohms. | 53. Condenser, 50, ufd, Plate Voltage |
| 22. Resistor, 2 ohms. | 54. Condenser (2), 8 ufd, Surge by-pass. |
| 23. Resistor, 11,000 ohms. | 55. Condenser, 250 mfd, Filament voltage |
| 24. Resistor, .3 ohms, Filter | 56. Ammeter, (Magnetstrom). |
| 25. Resistor, .5 ohms, Filter | 57. Resistor, 100 ohms, filament voltage. |
| 26. Resistor, 1 ohm, Rect. Bias. | |
| 27. Resistor, 1 ohm, Rect. Bias. | |
| 28. Reichweite Switch (Range Control Knob). | |
| 29. No Assignment | |
| 30. No Assignment | |
| 31. Resistor, 5000 ohms, B plus | |
| 32. Resistor, 1000 ohm, Transformer coupling circuit. | |

58. Resistor, 100 ohms, filament voltage.
59. Resistor, 100 ohms, Rectifier Plate Isolating.
60. Fuse, 1 Amp.
61. Power Switch
62. Fuse, 8 Amp.
63. Fuse, 0.6 Amp.
64. Fuse 0.1 Amp.
65. Fuse, 6 Amp.
66. Main Switch (Hauptschalter).
67. No Assignment.
68. Meter release Button (Drucken).
69. Line Breaking Switch (red button)
70. No Assignment.
71. No Assignment.
72. Power Plug.
73. Cannon Plug.
74. No Assignment.
75. Battery Connection.
76. Dead Jack.
77. Control Line Jack.
78. No Assignment.
79. Choke, Line Filter.
80. Choke, Line Filter.
81. Condenser (2), Line Filter, .02 uf.
82. Condenser, .05 mfd shunt "Nets"
83. Cannon Connector "HF AMP".

UNCLASSIFIED

AD NUMBER

AD015850

NEW LIMITATION CHANGE

TO

Approved for public release, distribution unlimited

FROM

Distribution: Further dissemination only as directed by Wright Air Development Center, Wright-Patterson AFB, OH, 45433, or higher DoD authority.

AUTHORITY

AFAL ltr, 17 Aug 1979

THIS PAGE IS UNCLASSIFIED

Reproduced by

Armed Services Technical Information Agency
DOCUMENT SERVICE CENTER

KNOTT BUILDING, DAYTON, 2, OHIO

AD -

This Document
Reproduced From
Best Available Copy

15850

UNCLASSIFIED