

Balun Information

This page serves to warehouse and preserve reflector-based information on the subject of baluns for HF applications. In addition, the page offers vendor and product review links.

Definition	Talino, IZ7ATH has some very basic explanations of balun theory and construction	
Theory, Design, Performance, Construction and Opinions on what works and why	W0IYH Feed line Choke Performance (Tim, K3LR; Aug 18, 2003)	
	Coax balun on a PVC form (Ed, WA2SRQ; Aug 12, 1996)	
	K3LR and W0IYH "choke" baluns in the feedline system (Tom, W8JI; June 11, 1999)	
	An Inexpensive, High-Performance, Ugly 50ohm-Balun (Rich, AG6K)	
	C-31XR Balun (John, W7HJQ - Jan 13, 2001)	
	Radio Works Reference Pages	
	160m Baluns (Joe, W1JR - December 22, 2003)	
Vendors	Cal-AV Labs Inc	W2FMI high-power baluns
	Centaur Electronics	Array Solutions
	Radio Works	The Wireman
	Antennas and More	Palomar Engineers
	Davis RF	
Product Reviews	From eHam.net -- here is what people have to say about various balun products	

Last modified May 25, 2005 by Paul B. Peters, ve7avv@rac.ca.

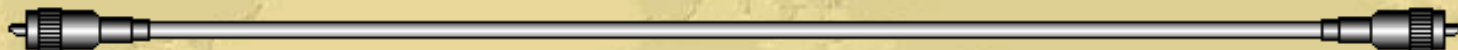

Local copies of reflector-based information presented below are simply a means to preserve the data for others to enjoy. The creator of this page recognizes the following information sources: TowerTalk reflector, Force-12 reflector, Rich Measures.

To: <towertalk@contesting.com>

Subject: [TowerTalk] W0IYH Feed line Choke Performance

From: k3lr@k3lr.com (Tim Duffy K3LR)

Date: Mon Aug 18 16:19:16 2003

I posted some of my experience concerning the W2DU type choke performance a few weeks ago. There were several requests for the test data. I retrieved my lab notes taken from my HP Network Analyzer on October 15, 2001.

The W0IYH choke is made from 100 type FB-5622-43 beads on RG-142 with silver plated PL-259's on each end.

The list is test frequency followed by impedance

1.8 MHz	1152 ohms
3.7 MHz	3483 ohms
7.1 MHz	4115 ohms
14.2 MHz	1783 ohms
21.2 MHz	1280 ohms
28.5 MHz	1234 ohms

My tests with the W2DU choke:

1.8 MHz	984 ohms
3.7 MHz	1733 ohms
7.1 MHz	1921 ohms
14.2 MHz	1432 ohms
21.2 MHz	905 ohms
28.5 MHz	423 ohms

In 100% key down CW tests into a 50 ohm dummy load for 10 minutes I found the W2DU to overheat (individual bead temperature exceeded manufactures ratings) at 500 watts on every band. The W0IYH choke passed the same test at 2000 watts and was well within the temperature specification for each bead. I believe the W0IYH choke has adequate safety factor for 1500 watt stations as long as the VSWR does not exceed 3:1.

There are lots of W2DU chokes in service and as you can see they will work well. The W0IYH design is an improved version. As I indicated in my September 1998 CQ Contest magazine article, I use the W0IYH design at my station. They are on every feed point of every antenna, at the tower mounted stacked antenna RF switch box and at the end of each antenna feed line where it connects to the RF amplifier in the radio room. They keep RF from flowing on the outside shields of the feed lines very well.

If you are interested in ready to go chokes, completed W0IYH chokes are available from Comtek Systems. Please contact them for price and availability.

<http://www.comteksystems.com>

73,
Tim K3LR

<http://www.k3lr.com>



Ed Gilbert eyg@hpnjlc.njd.hp.com

Mon, 12 Aug 1996 08:40:24 -0400

Hi Pete,

My experience is that PVC works fine as a form for high Q RF coils. I've measured Qs of up to 450 on loading coils wound on PVC pipe.

I've appended a paper I wrote on measurements of coaxial baluns wound on PVC forms.

73,

Ed Gilbert, WA2SRQ
eyg@hpnjlc.njd.hp.com

Having access to a Hewlett-Packard 4193A vector impedance meter at work, I have made measurements on a number of baluns, coaxial and otherwise. For my beams I was particularly interested how many turns and on what diameter are optimum for air core coaxial baluns, and what the effect of bunching the turns was (formless). Using the remote programming capability of the HP4193A along with an instrument controller, I measured the magnitude and phase of each balun's winding impedance at 1 MHz intervals from 1 to 35 MHz. For comparison, I also made measurements on a commercial balun which consists of a number of ferrite beads slipped over a short length of coax. I've appended some of these measurements so you can draw your own conclusions.

PVC pipe was used for coil forms. The 4-1/4 inch diameter baluns were wound on thin-walled PVC labeled "4 inch sewer pipe". This material makes an excellent balun form. It's very light weight and easy to work with, and I obtained a 10 foot length at the local Home Depot for about 3 dollars. The 6-5/8 inch diameter forms are 6 inch schedule 40 PVC pipe which is much thicker, heavier, and more expensive.

Each test choke was close-wound on a form as a single-layer solenoid using RG-213 and taped to hold the turns in place. The lengths of cable were cut so there was about 2 inches excess at each end. This allowed just enough wire at the ends for connections to the HP4193A's probe tip. After data was collected for each single-layer configuration, the PVC form was removed, the turns were bunched together and taped formless, and another set of measurements was taken. I have only included the "bunched" measurements in the table for one of the baluns, but the trend was the same in each case. When compared to the single-layer version of the same diameter and number of turns, the bunched baluns show a large downward shift in parallel self-resonance frequency and poor choking reactance at the higher frequencies.

Interpreting the Measurements

All the baluns start out looking inductive at low frequencies, as indicated by the positive phase angles. As the frequency is increased, a point is reached where the capacitance between the windings forms a parallel resonance with the coil's inductance. Above this frequency, the winding reactance is reduced by this capacitance.

The interwinding capacitance increases with the number of turns and the diameter of the turns, so "more is not always better".

The effects of a large increase in interwinding capacitance is evident in the measurements on the balun with the bunched turns. This is probably a result of the first and last turns of the coil being much closer together than the single-layer coil.

An important requirement of these baluns is that the magnitude of the winding reactance be much greater than the load impedance. In the case of a 50 ohm balanced antenna, the balun's winding impedance is effectively shunted across one half the 50 ohm load impedance, or 25 ohms. A reasonable criteria for the balun's winding impedance for negligible common mode current in the shield is that it be at least 20 times this, or 500 ohms. The measurements show, for example, that 6 turns 4-1/4 inches in diameter meet this criteria from 14 to 35 MHz.

The measurement data also reveals the power loss these baluns will exhibit. Each of the measurement points can be transformed from the polar format of the table to a parallel equivalent real and reactive shunt impedance. The power dissipated in the balun is then the square of the voltage across it divided by the real parallel equivalent shunt impedance. While this calculation can be made for each measurement point, an approximate number can be taken directly from the tables at the parallel resonance points. At 0 degrees phase angle the magnitude numbers are pure resistive. I didn't record the exact resonance points, but it can be seen from the tables that the four single-layer baluns are all above 15K ohms, while the ferrite bead balun read about 1.4K. These baluns see half the load voltage, so at 1500 watts to a 50 ohm load, the power dissipated in the coaxial baluns will be less than 1.3 watts, and the ferrite bead balun will dissipate about 13.4 watts (neglecting possible core saturation and other non-linear effects). These losses are certainly negligible. At 200 ohms load impedance, the losses are under 5 watts for the coaxial baluns and 53.6 watts for the ferrite beads.

Conclusions

- A 1:1 coaxial balun with excellent choking reactance for 10 through 20 meters can be made by winding 6 turns of RG-213 on inexpensive 4 inch PVC sewer pipe.
- For 40 or 30 meters, use 12 turns of RG-213 on 4 inch PVC sewer pipe.
- Don't bunch the turns together. Wind them as a single layer on a form. Bunching the turns kills the choking effect at higher frequencies.
- Don't use too many turns. For example, the HyGain manuals for my 10 and 15 meter yagis both recommend 12 turns 6 inches in diameter. At the very least this is about 3 times as much coax as is needed, and these dimensions actually give less than the desired choking impedance on 10 and 15 meters.

Measurements

 Magnitude in ohms, phase angle in degrees, as a function of frequency
 in Hz, for various baluns.

Frequency	6 Turns 4-1/4 in snagl layer		12 Turns 4-1/4 in snagl layer		4 Turns 6-5/8 in snagl layer		8 Turns 6-5/8 in snagl layer		8 Turns 6-5/8 in bunched		Ferrite beads (Aztec)	
	Mag	Phase	Mag	Phase	Mag	Phase	Mag	Phase	Mag	Phase	Mag	Phase
1.00E+06	26	88.1	65	89.2	26	88.3	74	89.2	94	89.3	416	78.1
2.00E+06	51	88.7	131	89.3	52	88.8	150	89.3	202	89.2	795	56.1
3.00E+06	77	88.9	200	89.4	79	89.1	232	89.3	355	88.9	1046	39.8
4.00E+06	103	89.1	273	89.5	106	89.3	324	89.4	620	88.3	1217	26.6
5.00E+06	131	89.1	356	89.4	136	89.2	436	89.3	1300	86.2	1334	14.7
6.00E+06	160	89.3	451	89.5	167	89.3	576	89.1	8530	59.9	1387	3.6
7.00E+06	190	89.4	561	89.5	201	89.4	759	89.1	2120	-81.9	1404	-5.9
8.00E+06	222	89.4	696	89.6	239	89.4	1033	88.8	1019	-85.7	1369	-15.4
9.00E+06	258	89.4	869	89.5	283	89.4	1514	87.3	681	-86.5	1295	-23.7
1.00E+07	298	89.3	1103	89.3	333	89.2	2300	83.1	518	-86.9	1210	-29.8
1.10E+07	340	89.3	1440	89.1	393	89.2	4700	73.1	418	-87.1	1123	-35.2
1.20E+07	390	89.3	1983	88.7	467	88.9	15840	-5.2	350	-87.2	1043	-39.9
1.30E+07	447	89.2	3010	87.7	556	88.3	4470	-62.6	300	-86.9	954	-42.7
1.40E+07	514	89.3	5850	85.6	675	88.3	2830	-71.6	262	-86.9	901	-45.2
1.50E+07	594	88.9	42000	44.0	834	87.5	1910	-79.9	231	-87.0	847	-48.1
1.60E+07	694	88.8	7210	-81.5	1098	86.9	1375	-84.1	203	-87.2	778	-51.8
1.70E+07	830	88.1	3250	-82.0	1651	81.8	991	-82.4	180	-86.9	684	-54.4
1.80E+07	955	86.0	2720	-76.1	1796	70.3	986	-67.2	164	-84.9	623	-45.9
1.90E+07	1203	85.4	1860	-80.1	3260	44.6	742	-71.0	145	-85.1	568	-51.2
2.00E+07	1419	85.2	1738	-83.8	3710	59.0	1123	-67.7	138	-84.5	654	-34.0
2.10E+07	1955	85.7	1368	-87.2	12940	-31.3	859	-84.3	122	-86.1	696	-49.9
2.20E+07	3010	83.9	1133	-87.8	3620	-77.5	708	-86.1	107	-85.9	631	-54.8
2.30E+07	6380	76.8	955	-88.0	2050	-83.0	613	-86.9	94	-85.5	584	-57.4
2.40E+07	15980	-29.6	807	-86.3	1440	-84.6	535	-86.3	82	-85.0	536	-58.8
2.50E+07	5230	-56.7	754	-82.2	1099	-84.1	466	-84.1	70	-84.3	485	-59.2
2.60E+07	3210	-78.9	682	-86.4	967	-83.4	467	-81.6	60	-82.7	481	-56.2
2.70E+07	2000	-84.4	578	-87.3	809	-86.5	419	-85.5	49	-81.7	463	-60.5
2.80E+07	1426	-85.6	483	-86.5	685	-87.1	364	-86.2	38	-79.6	425	-62.5
2.90E+07	1074	-85.1	383	-84.1	590	-87.3	308	-85.6	28	-75.2	387	-63.8
3.00E+07	840	-83.2	287	-75.0	508	-87.0	244	-82.1	18	-66.3	346	-64.4
3.10E+07	661	-81.7	188	-52.3	442	-85.7	174	-69.9	9	-34.3	305	-64.3
3.20E+07	484	-78.2	258	20.4	385	-83.6	155	-18.0	11	37.2	263	-63.2
3.30E+07	335	-41.4	1162	-13.5	326	-78.2	569	-0.3	21	63.6	212	-58.0
3.40E+07	607	-32.2	839	-45.9	316	-63.4	716	-57.6	32	71.4	183	-40.5
3.50E+07	705	-58.2	564	-56.3	379	-69.5	513	-72.5	46	76.0	235	-29.6



To: <towertalk@contesting.com>

Subject: [TowerTalk] K3LR and W0IYH "choke" baluns in the feedline system

From: W8JI@contesting.com (Tom Rauch)

Date: Fri, 11 Jun 1999 09:18:38 -0400

I've had some telephone line caused server problems, and I'm not sure my post made it to the reflector or anywhere.

From: "Greg Gobleman" <k9zm@frontiernet.net>
To: "Tod-ID" <tao@skypoint.com>, <towertalk@contesting.com>,
"Bill Coleman AA4LR" <aa4lr@radio.org>
Subject: Re: [TowerTalk] K3LR and W0IYH "choke" baluns in the
feedline system
Date sent: Thu, 10 Jun 1999 20:02:45 -0500

> I also read W2FMI's book and I would have to agree that something isn't
> right about the W2DU type Balun. I experienced heating and a rise in SWR
> when using a KW and an under 2:1 SWR but not flat. It would heat up and
> the standing wave would rise over 2:1. This is not to say that all bead
> Baluns are bad. I had heard good things about the Force 12 version.
> Perhaps it uses a different ferrite material.

Walt's balun is based on good engineering for choking, but if you look at it closely there is no headroom for power. I suspect Walt never caught that because he mostly runs low power.

There are certainly many cases where his balun would work OK, but 73 material or ANY material with high loss tangent is the wrong material for QRO or for use where the core is involved in handling any high flux density.

> I built several of the W1JR type of Baluns and have had no problem with
> heating. I have had a problem finding an inexpensive enclosure. I have
> tried using 3" PVC caps and plugs and have about \$5 in the enclosure.
> However, I created another problem. Weight of the enclosure and the
> core/coax with connectors is a bit much for a dipole. An inverted V or
> mounting on a beam is not a problem.

There is no need for the criss-crossed winding style, a single layer solenoid winding measures nearly the same. Some articles and books tell you any stray C across the balun reduces choking, but the opposite actually happens. You just have to be careful and not use such a large winding that the self-resonant frequency of the balun is lower than $1/2$ of the highest operating frequency.

The cheapest balun for a given impedance and power rating is still an air-wound coil of coax on a PVC drainpipe.

> I have also had excellent success with a coil of coax. When ur lighting
> every florescent tube within a block at 2 AM while on 80m with a flat SWR.
> This will cure it.

If you use multiple turns through a core, the impedance goes up by the square of the turns increase. If you stick them through a string of beads, the increase in impedance is linear with length and has almost nothing to do with bead thickness. An air wound choke is somewhere between unity ratio and squared impedance as turns are increased, depending on mutual coupling between turns.

A string of 43 material beads 36 inches long has the same common mode impedance as a stack of 43 cores 1 inch tall with 6

turns of coax. The string of beads will handle more power, because it has more surface area exposed directly to cooling air no matter how thick the beads are (beyond a certain limit).

The more stress the balun has, the lower the μ of the core you should use. At the feedpoint with high power, a low- μ low-loss-tangent core is generally best, like air or a 61 material. This is especially true if the feedline parallels the antenna, or if the element is off balance, or if the element impedance is high.

In a coaxial line connected the normal way near the shack (like in the second chokes K3LR uses), a string of 73 material beads would almost certainly be acceptable no matter what the power level.

The feedline should be grounded to the tower or another ground as soon as possible after the balun, only on the side of the balun closest to the shack if possible.

I use air chokes, or 61 material cores at transmitting antennas. I use 73 or 75 material cores for receiving and in-the-shack or "down the cable a distance" isolation.

73, Tom W8JI

w8ji@contesting.com



An Inexpensive, High-Performance, Ugly 50ohm-Balun

Building a no-grief 1.8MHz to 30MHz 50ohm-balun is easy. No costly ferrite-cores are needed, just a short length of 3 to 5 inch size plastic pipe, about 25 feet of 50ohm coax plus some nylon cable ties. Solid-dielectric coax is best for this application because foam-dielectric has a tendency to allow a change in the conductor to conductor spacing over a period of time if it is bent into a tight circle. This can eventually result in voltage breakdown of the internal insulation. The required length of the plastic pipe depends on the diameter and length of the coax used and the diameter of the pipe. For RG-213/U coax, about one foot of 5 inch size pipe is needed for a 1.8MHz to 30MHz balun. For 3.5MHz to 30MHz coverage, about 18 to 20 feet of coax is needed. This length of coax is also adequate for most applications on 1.8MHz. The number of turns is not critical because the inductance depends more on the length of the wire (coax) than on the number of turns, which will vary depending on the diameter of the plastic pipe that is used. The coax is single-layer close-wound on the plastic pipe. The first and last turns of the coax are secured to the plastic pipe with nylon cable ties passed through small holes drilled in the plastic pipe. The coil winding must not be placed against a conductor. The name of this simple but effective device is a choke-balun.

Some people build choke-baluns, without a plastic coil-form, by scramble-winding the coax into a coil and taping it together. The problem with scramble-winding is that the first and last turns of the coax may touch each other. This creates two complications. The distributed-capacitance of the balun is increased and the RF-lossy vinyl jacket of the coax is subjected to a high RF-voltage. The single-layer winding on the plastic coil-form construction method solves these problems since it divides the RF-voltage and capacitance evenly across each turn of the balun.

A more compact, less ugly, 1 to 1 impedance-ratio, 50ohm trifilar-wound (with wire) ferrite-core balun could also be used but there would be some tradeoffs. Ferrite cores are not cheap. Also, the air-core of the coax-balun can't saturate like the ferrite-core and, unlike ferrite-core wire-wound baluns, single-layer wound coax-baluns almost never have an insulation breakdown problem. Also, a trifilar-wound balun does not like to work into anything but a perfectly balanced load. With an imperfectly balanced load, the coax-balun will not, as does the trifilar balun, generate a differential, third RF-current on the outside of the coax that brings the RF to the input of the tuner. The choke-balun is not fussy. It will work as well into a less than perfectly balanced load as it will into a perfectly balanced load, and do so without the possibility of creating a differential RF-current on

the station ground and fricasseeing the operator's fingers.



Subject: C-31XR Balun ...

Author: John Petrich <petrich@u.washington.edu>

Date: 13-Jan-2001 20:39:50

Hi Greg,

Thanks for the reply and comments about baluns. It is good to share ideas with people who make observations and have ideas.

Yes, I am familiar with the W1JR balun and have used it in some applications. It was good 30 years ago, it is still good today. The only reason that it is not as popular as it once was, is that the bead baluns are easier to construct and harder to goof up on. There may be a small advantage in terms of bandwidth for the bead baluns. In some applications, bandwidth is very important. In other applications, bandwidth is really not important at all.

I know what you mean about unrecognized balun heating. So many baluns are located up at the antenna feedpoint and the heating is only discovered after the balun has failed. Antennas can be properly constructed yet it is of major importance to pair the balun, the antenna and the band of operation correctly to avoid balun heating and unwanted feedline radiation. Feedline radiation isn't always a problem. Wanted feedline radiation can make for a useful antenna i.e. G5RV.

Balun heating is the result of common mode currents flowing on the outside of the coax shield. These currents are then dissipated in the real component of the complex common mode impedance characteristic for that balun. There is no other source for heating for the ferrite beads. This heating problem occurs just the same way and for the same reason with all ferrite baluns, whether they are constructed with ferrite toroids or ferrite beads. The phenomenon is the same. It is interesting, if you carefully examine an overheating bead balun, the beads closest to the high impedance connections are the warmest. The beads closest to the low impedance connections are the coolest. It is as if each little bead functions as an individual little attenuator element. The entire stack of ferrites does not act like a resistor. The power from the common mode current is not dissipated uniformly as it would along a purely resistive element.

There are two independent factors that contribute to common mode current flow and the resultant risk of balun heating:

1) **INSUFFICIENT COMMON MODE IMPEDANCE TO CHOKE OFF COMMON MODE CURRENT FLOW:** Anytime, repeat "anytime", one of these 800 ohm common mode impedance bead baluns is connected across a high impedance load, such as a 80 meter doublet excited on 40 meters, there is the risk of severe balun overheating. The same goes for trying to operate a old style tribander on 17 or 24 meters with a ferrite balun. Low power operation won't heat the balun, BUT, the common mode current is still flowing, and the system could be operating at a disadvantage. This limitation from the balun's common mode impedance in a high impedance environment is **BY FAR THE MOST SIGNIFICANT FACTOR** that contributes to bead balun overheating. High power makes the heating problem easier to recognize. Low power doesn't cause as much heating but the system may not be functioning in an ideal manner. But, "everything works." A better solution for a balun in a high impedance environment is to use one of those coiled coax or "Badger", baluns. This particular style of balun is capable of exhibiting extremely high common mode impedance values if properly constructed and tested for the frequency of use. Just like an old antenna tuner of years gone by.

2) **FERRITE MIX:** Yes, ferrite mix can make a difference, but don't get overly excited on this one. Any importance that ferrite mix has on balun heating is not because one mix is "better" than another, or one mix is "worse" than another. The reason that ferrite mix can contribute to balun overheating problems is because of #1 above- Insufficient Common Mode Impedance. The Force-12 balun, I'm guessing, acts like a string of #43 mix ferrite beads. The Maxwell, W2DU, bead balun uses a string of #77 mix ferrite beads. The Force -12 balun has a good peak common mode impedance from 40 meters to 10 meters. The Maxwell bead balun has a useful peak common mode impedance from 160 through 15 meters. There is substantial overlap for both and both are good. The Maxwell balun might not have enough common mode impedance on 10 meters and overheat in some 10 meter applications. The Force 12 balun might not have enough common mode impedance for a 160 meter installation and overheat in some applications on that band. I haven't actually tested each balun side by side in the antenna situations I have referred to but I am extrapolating from their common mode impedance curves.

The key to reducing balun overheating probably lies with pairing up the antenna (and its feed point impedance), and band of operation, with a balun having sufficient common mode impedance to choke off common mode current flow. The standard of comparison between "current mode" baluns is their measured common mode impedance at the frequency of use. Some "current mode" baluns have low common mode impedance compared to other baluns. I have only tested the Force-12 and Maxwell baluns and they exhibit common mode impedances of about 800 ohms. Unfortunately, the various manufacturers never publish the common mode impedance characteristics of their baluns. I think that it is very very very hard to get common mode impedance values greater than 800 to 1000 ohms using low Q type #43 and #77 ferrites. Maybe I don't know enough, so take that statement with a grain of salt. One can get relatively high common mode impedance by coiling coax on a higher Q #61 ferrite toroid. The air coiled coax, "Badger, balun or an old fashioned antenna tuner will give the highest common mode impedance values that I know of.

Let me know your thoughts, Greg.

John Petrich, W7HQJ 

Subject: Re: Topband: 160 Meter BALUNS

From: Joe Reisert <W1JR@arri.net>

Date: Mon, 22 Dec 2003 10:24:03 -0500

Hi Tom,

A follow up to my prior EMail on a solenoid baluns.

Regardless of whether 50 feet of RG8X wound on a solenoid (tube) is proper to use a balun or not, I'll leave that up to you and W8JI to decide. I guess you some would describe this type of balun as a choke.

Now, here is some more theoretical information and measurements etc. that maybe of interest to some for the engineering types on this reflector. This maybe helpful to design similar types of solenoid baluns at other frequency bands.

50 feet of RG8X coax is a good starting point for a 160 meter solenoid (choke) balun for many reasons. If you close wind the coax on a 4.5" OD (I mistakenly said 4" in my prior EMail) standard white PVC tube, you obtain an impedance of about 650 Ohms (as measured on an HP Network analyzer). This means that you are above the 500 Ohms (and well above 250 Ohms) impedance that most experts feel is adequate for a balun impedance.

At 80 meters, the same solenoid balun will have an measured impedance of about 1300 Ohms. However, depending on how tight you make the turns, a resonance will be noted somewhere between 12 and 15 MHz. Hence, 50 feet of coax is probably only good for 160 through 30 meters. Use less turns if only for higher bands (see below). It looks like a 4 or 5:1 ratio of lowest frequency to highest useable frequency is a good rule of thumb.

To carry on further, 50 feet of RG8X will amount to approximately 38 turns on a 4.5" OD former and the winding will be approximately 9.25" long. If you plug these numbers is into most standard equations to calculate inductance, you will calculate an inductance of approximately 60 micro Henries. Using the standard formula for reactance: $X_L = 2 \pi F L$, yields about the same impedance as measured above. Pretty nifty to get such agreement! So, you can see that don't need fancy measuring gear to make a solenoid balun for any band. Just decide on how high an impedance you want (but not too high-see below) and make sure that you don't put on too many turns so resonances will occur above rather than in band!

Some may ask if RG58 is OK for a solenoid balun. Sure it is but for lower power than RG8X. Since it is slightly smaller in diameter, 50 feet have a slightly higher impedance. Since the power handling ability of coax goes down as frequency increases, it maybe safer to use Teflon (RTM) type coax such as RG303 if you are running high power, especially at 80 meters and above. RG8 will also be OK but it is larger in diameter so more coax will be required. You can make your own calculations on this one. I wouldn't recommend foam RG8 coax as it may deform on such a small diameter. However, if you use a larger diameter tube, that will work with RG8 and since the diameter is larger, the impedance will increase accordingly. Use the standard inductance equations.

I made a solenoid balun with 25 feet of RG303 teflon (RTM), about 20 turns on a 4.5" tube, and the first measured resonance was about 24 MHz. This balun would be great, even at high power, for 80 through 15 meters. Again, about a 5:1 frequency range.

Some purists will say to space the turns, for example, by the diameter of the coax. This maybe less of a problem for flash over if lightning hits. I'll leave that up to you to decide. However, using the info above, this would calculate (using standard inductor equations) to about 33 micro Henries of inductance for space windings (and an impedance of only 375 Ohms), well below that normally suggested for a 160 meter balun. Hence, more coax or a larger diameter tube is required.

Finally, what about laying the balun on the ground. I'd recommend against that simply because that at least may lower the self resonance frequency. This is the old story that you shouldn't place objects near (1-3 diameters away) an inductor (which is what a solenoid balun is on the outside shield).

I hope this info is of interest and help. There will always be the disagreements over whether to use ferrite beads, ferrite toroids or solenoid baluns. No one size fits all! However, for those interested in designing their your own solenoid type baluns, I've hopefully given some info on how to "roll your own."

Happy holidays and best of DX in 2004.

73,

Joe, W1JR



[GO TO HOME PAGE](#)

[Teory](#) [Practice](#) [My Balun](#)

ABOUT BALUN

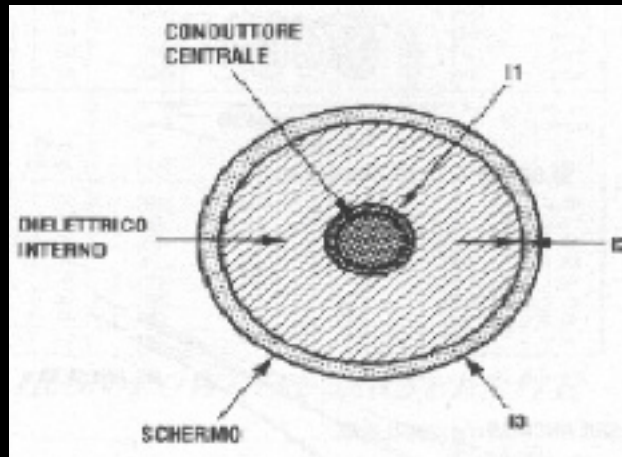

May be baluns are still a mystery for hams; the only way to understand it is learning what it is and how to use it.

The word balun means balanced-unbalanced: it's used to adapt a balanced device to an unbalanced one; in a balanced device (as larger type of antennas) we have on both terminal the same voltage respect to the ground (if not so it's an unbalanced device);

a dipole with direct feed is balanced, a coaxial cable is unbalanced.

So, when we connect a balanced device to an unbalanced one the following occurs:

we have a dipole with coaxial cable direct fed (i.e. RG213); normally, transmitting, there are 2 currents on the cable:

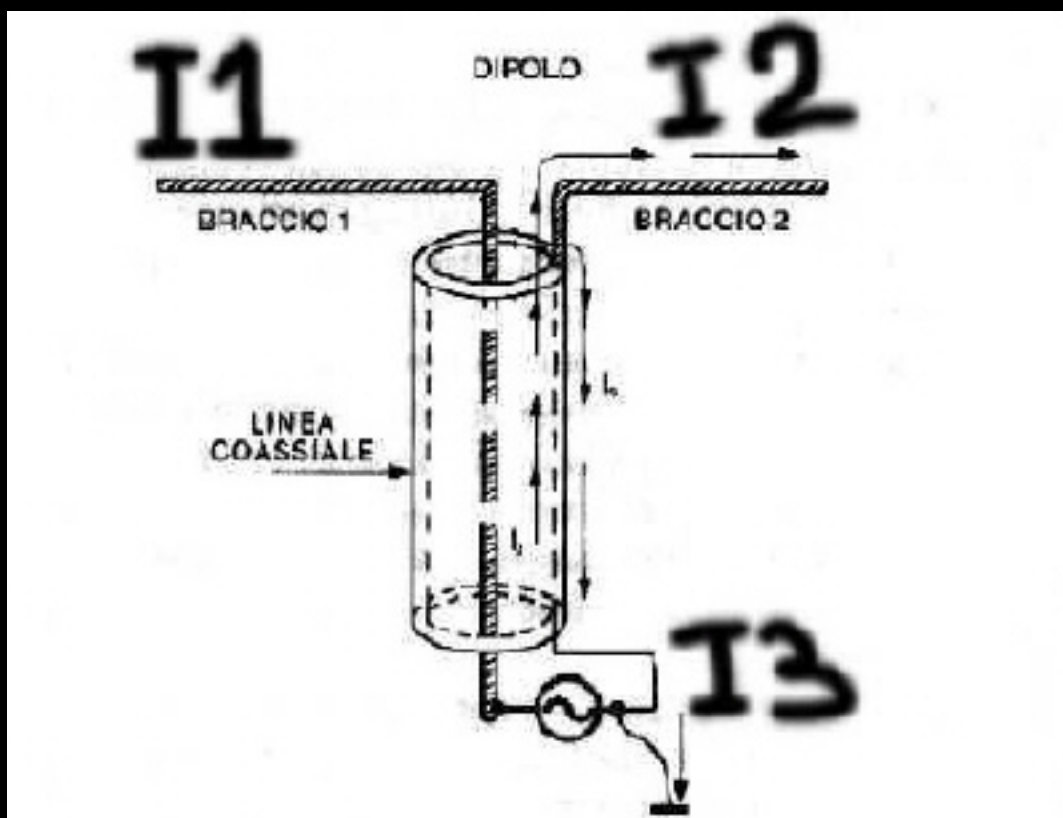

1. I_1 , which flows through the central wire of coaxial cable and from transmitter goes up to the dipole;
2. I_2 , which flows (for the skin effect) on the inside part of the copper shield;

The two currents, equal and opposite, cancel themselves and we have no radiation from coaxial cable.

The two currents come on the dipole to be irradiated; part of it comes back; the one on the shield comes back through the external side of the shield (no more the inside: so we have 2 current on the shield, I_2 and I_3); the value of this current (which we'll call I_3) depends to the impedance value of the external side of coaxial cable respect to the ground (in a word if it will find high or low resistance); if impedance will be high, I_3 will find high resistance and its value will be low; if impedance will be low, resistance will be low and I_3 value will be high; in this way I_3 will radiate RF and the external side of the coaxial cable will radiate as a third wire of dipole: it's as we have a dipole with 3 wire ([see picture 1](#)); as consequence the radiation pattern will be distorted ([see picture 2](#));

the big problem is that this new wire is often near TV and telephon cables irradiating directly on those: so we have more probabilities to cause TVI.

This new wire, when its impedance is low, change the dipole impedance so we can have high S.W.R; this is the reason why (without balun) varying the coaxial cable length the S.W.R. changes.

Let's see now why use a balun; to delete this current I_3 , we need an high

impedance for RF on the external side of coaxial cable; so we have high impedance casually for some cable length (odd multiple of $1/4 \lambda$) or using a balun: so the first reason to use a balun is TO AVOID THAT ON THE EXTERNAL SIDE OF COAXIAL CABLE FLOWS A CURRENT I_3 .

The simpler balun is a coil with some coaxial cable turns just below the antenna feed point: this inductance make the cable impedance (we mean the external side of cable shield) higher so that the RF current will find an high resistance and its value will be very low (that will not disturb I_2 and I_1 which flow inside the coaxial cable).

[Continue...](#)

[GO TO HOME PAGE](#)

CURRENTS IN A DIPOLE

[Back](#)

currents in a dipole without balun

schematic of a dipole without balun

[Back](#)

[GO TO HOME PAGE](#)

THE ACTION OF BALUN

[Back](#)

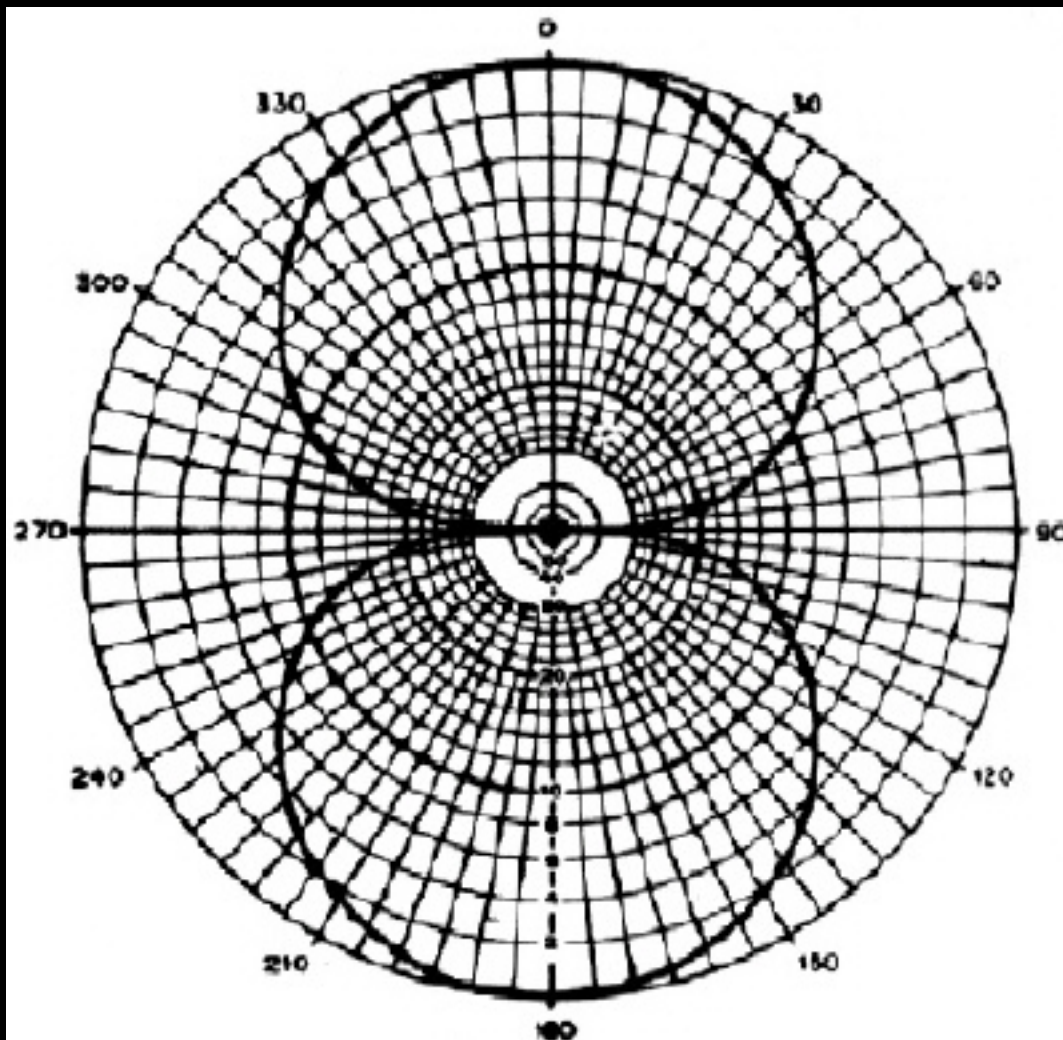

radiation diagram of a dipole with balun in free space

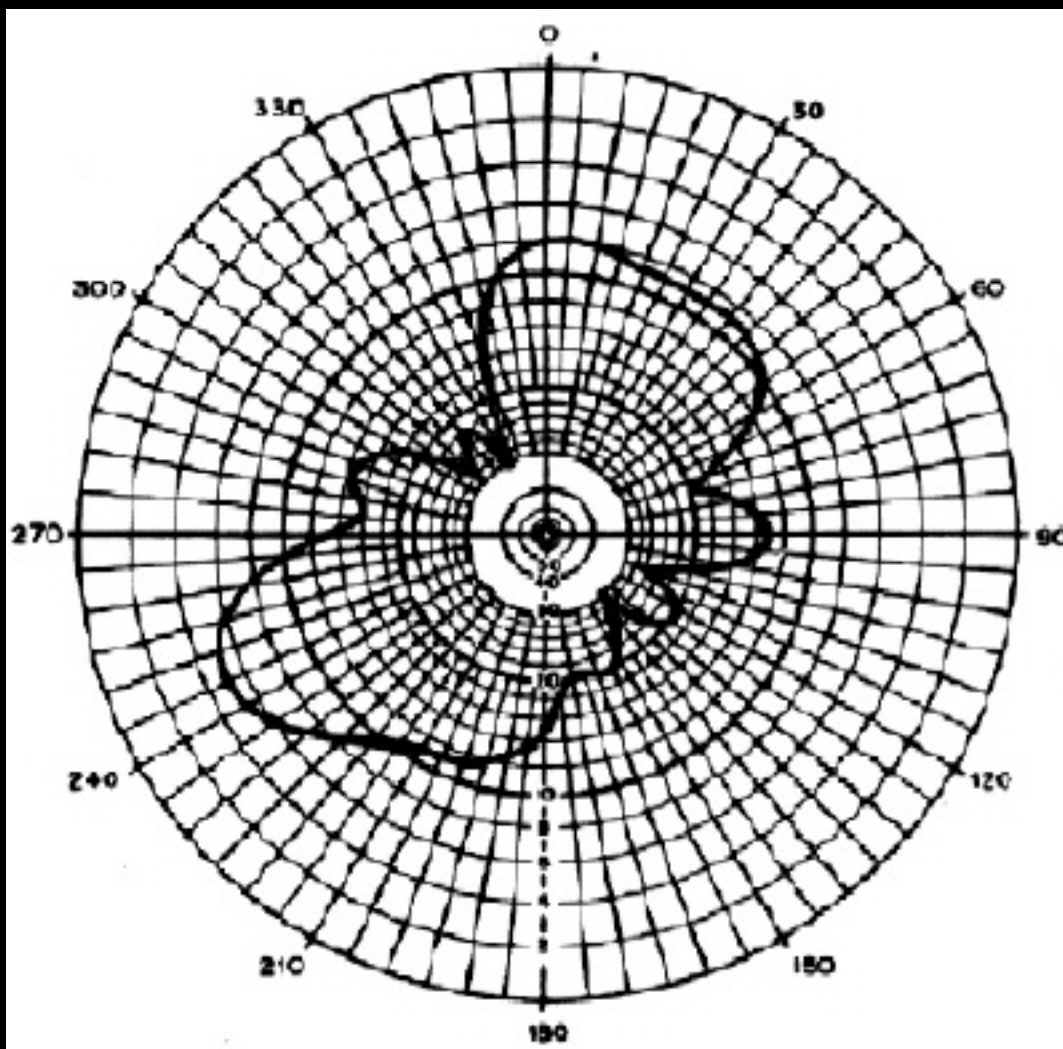

radiation diagram of a dipole without balun

[Back](#)

[GO TO HOME PAGE](#)

[Teory](#) [Practice](#) [My Balun](#)

TECNICAL DATA ABOUT BALUN

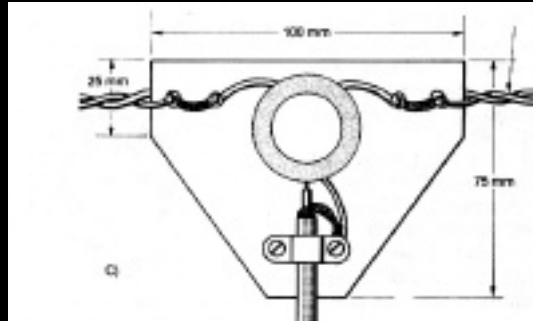

We can build a balun in various ways:

- **choke balun** ([see picture 1](#)) with ratio 1:1 : as we said, the easier way is a coil with 6-8 turns (diameter 20-30 cm for 14-30 mhz) of coaxial cable just below the dipole (or other balanced antenna) feed point; for low band add more turns or use a ferrite (like Amidon) wich has no influence on I1 and I2.

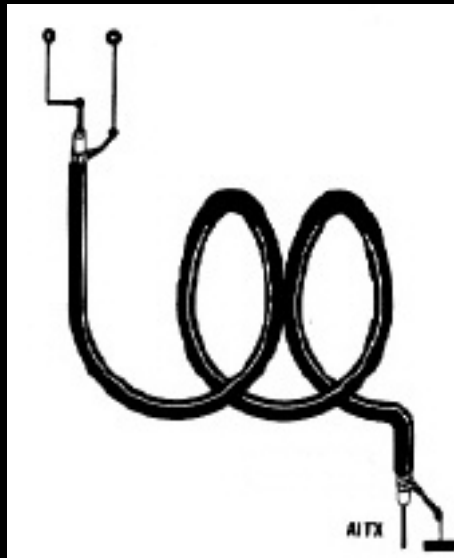

- **collins balun** ([see picture 2](#)) with ratio 1:1: the bandwidth is very wide; we have also a similar one but with ratio 4:1 ([see picture 3](#));
- **transmission line balun**: a transmission line transformer is composed of two (or more) transmission lines of X impedance connected between in series at one end and in parallel at the other one; turning this line as a coil we obtain high impedance for RF;

the balun on [picture 4](#) has a ratio of 1:1;
 the balun on [picture 5](#) has a ratio of 4:1;
 the baluns on [picture 6](#) have a ratio of 6,25:1 and 9:1;
 the line length should be $1/4$ lambda at the lower frequency.
 We can use a ferrite (as Amidon) to make the size smaller.

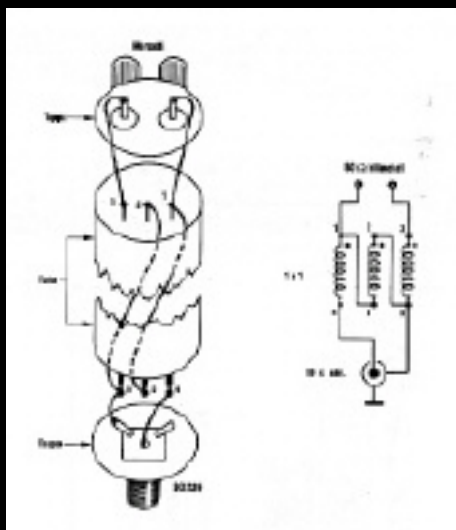

- bazooka balun ([see picture 7](#)) with ratio 1:1: it's a simple conductor pipe of $1/4$ lambda length placed around the coaxial cable and short-cut and the low-end; it has a small bandwidth and usually it's used on VHF; in VHF it's made with a metallic pipe, in HF it's made with metallic sheet wrapped around the coaxial cable (es.:carta stagnola) and short-cut with a pin at the low end (short-cut only the metallic sheet with the cable shield).



- VHF balun ([see picture 8](#)) with ratio 4:1: it's very common in VHF. The length L should be exactly $1/2$ lambda.
- All above baluns can be made using ferrite to make the size smaller ([see picture 9](#)).

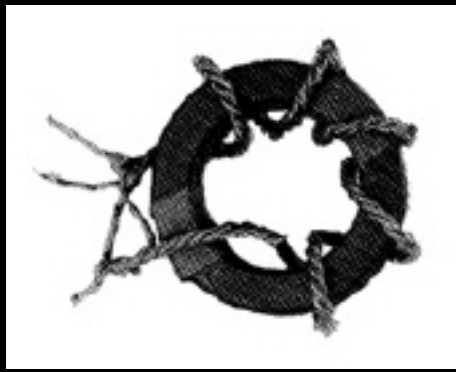

[Continue...](#)

[GO TO HOME PAGE](#)

CHOKE BALUN 1:1

[Back](#)

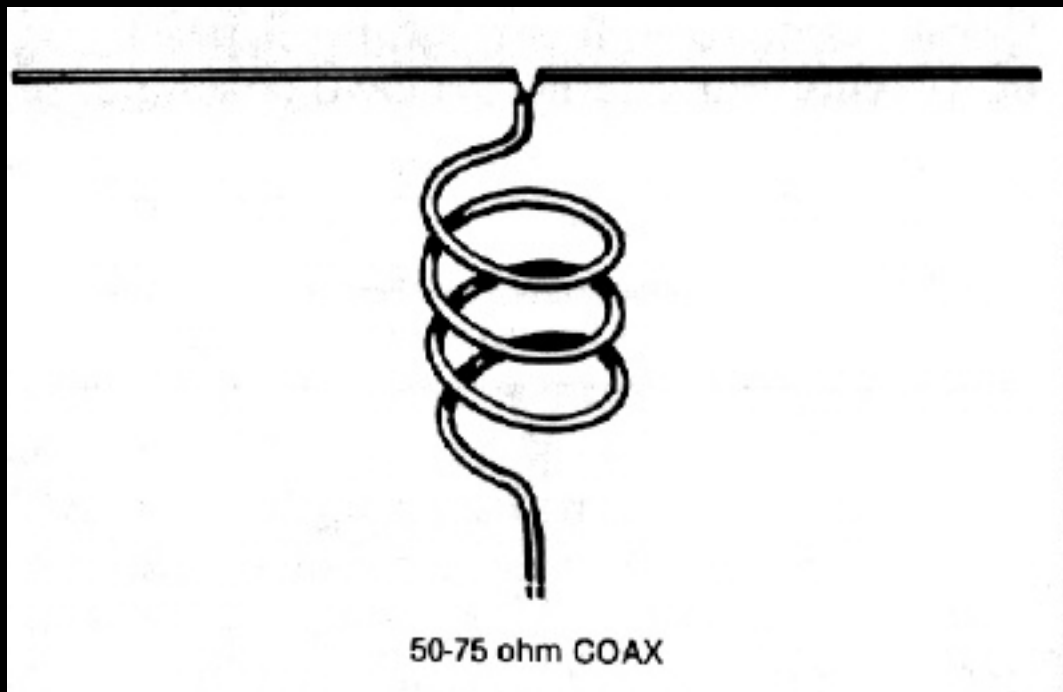

choke balun

[Back](#)

[GO TO HOME PAGE](#)

COLLINS BALUN 1:1

[Back](#)

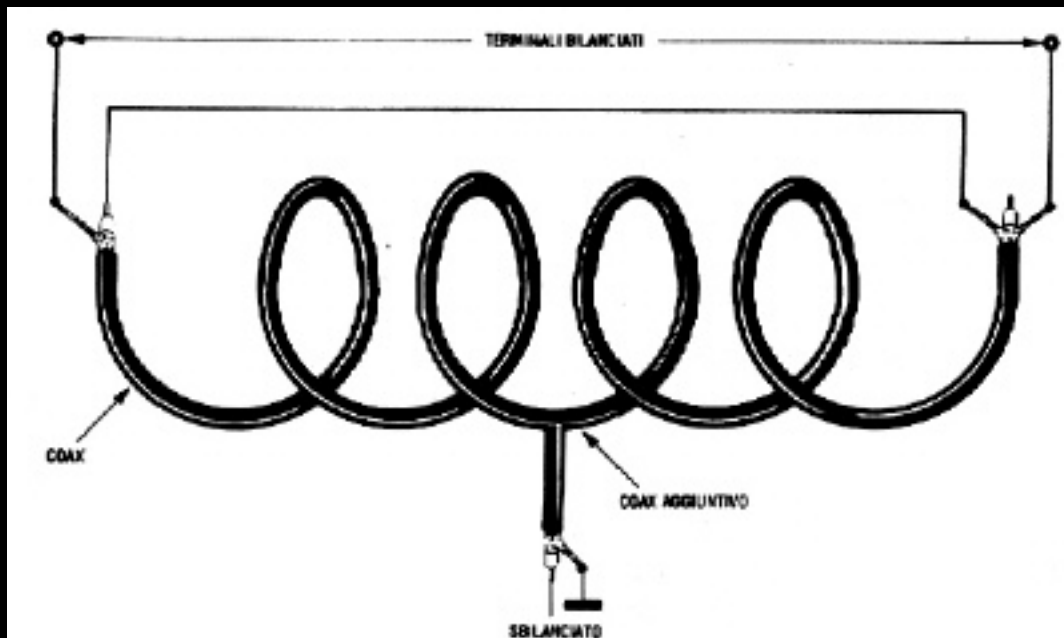

collins balun 1:1

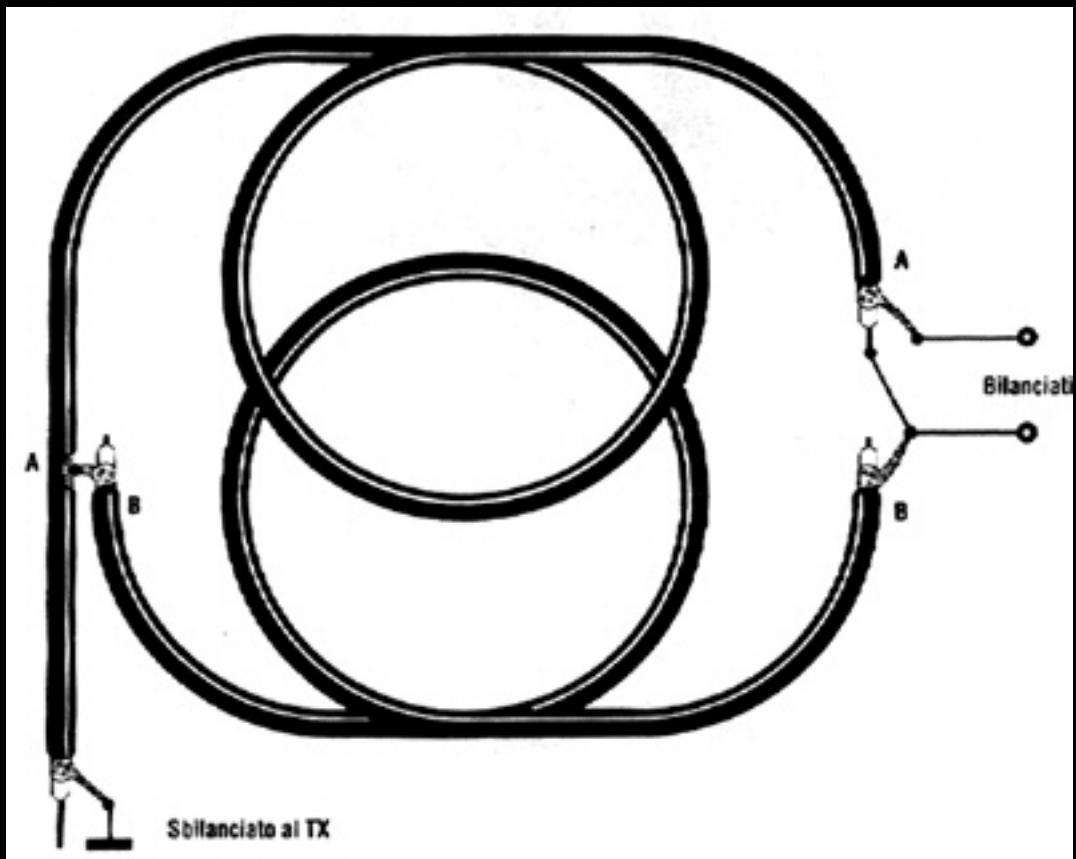

collins balun 1:1

For a range of 3 - 28 Mhz, you can use 130 cm of coax cable for each side (A, B), make 7-8 turns on 11 cm diam.

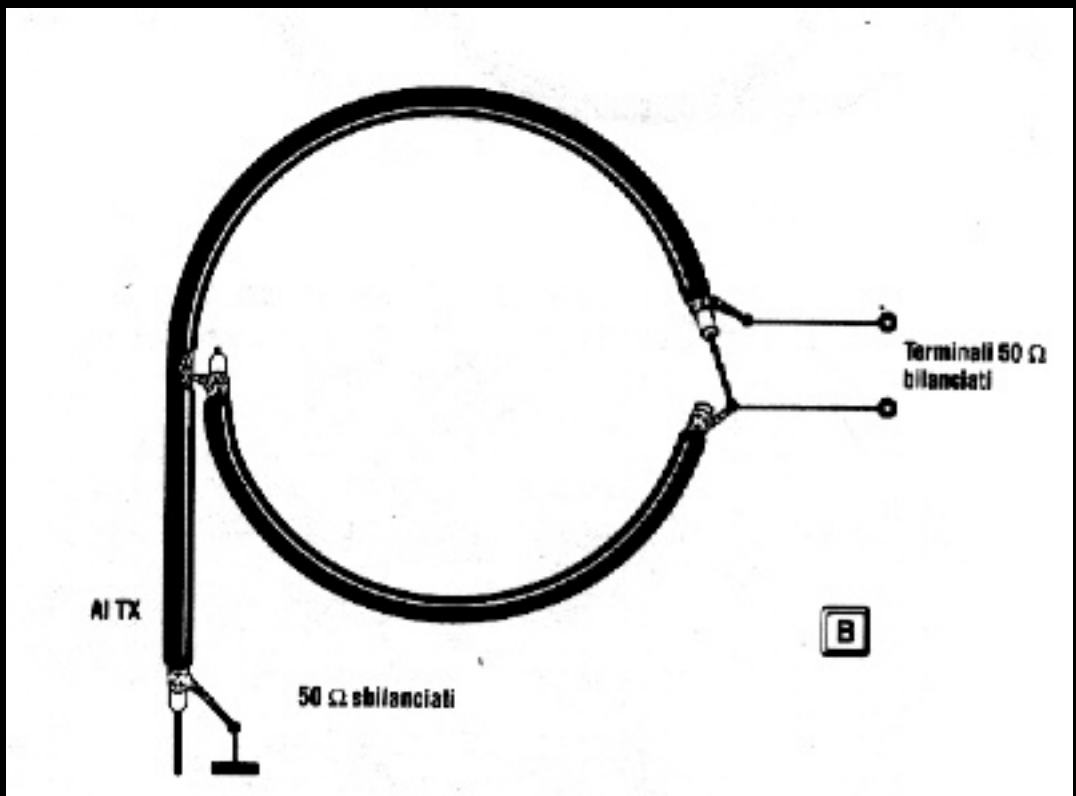

the same as above with only 1 turn (just to understand schematic)

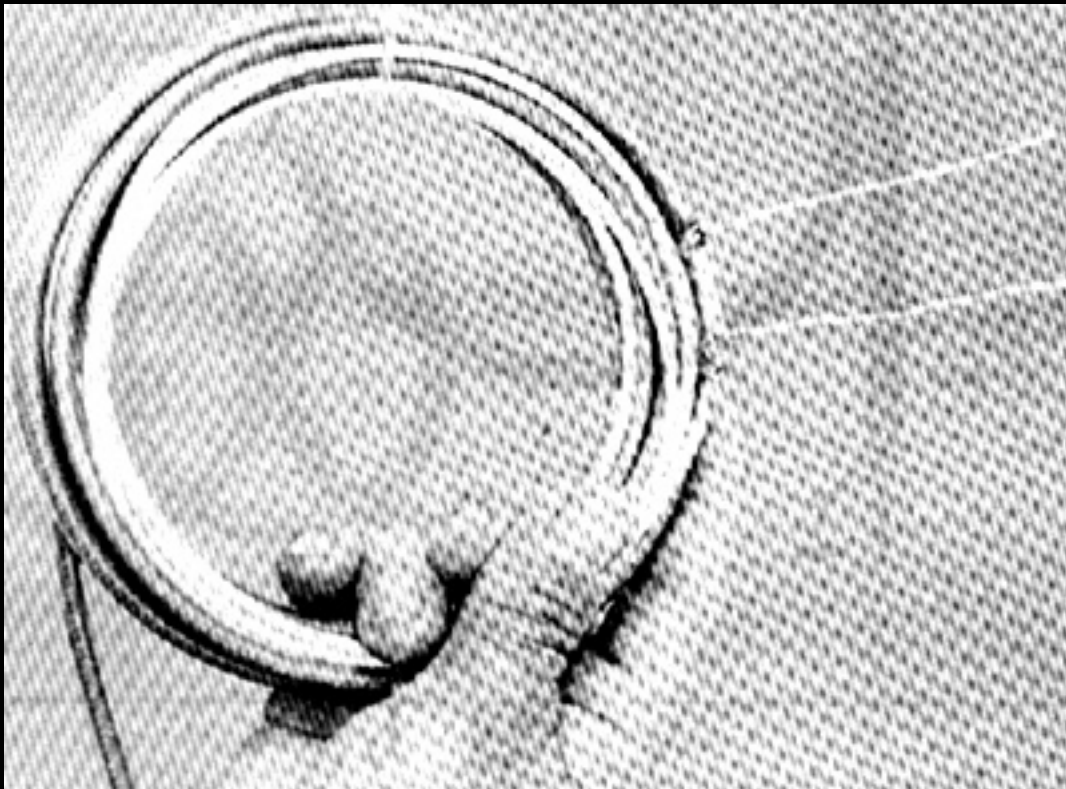

collins balun made with teflon-cable

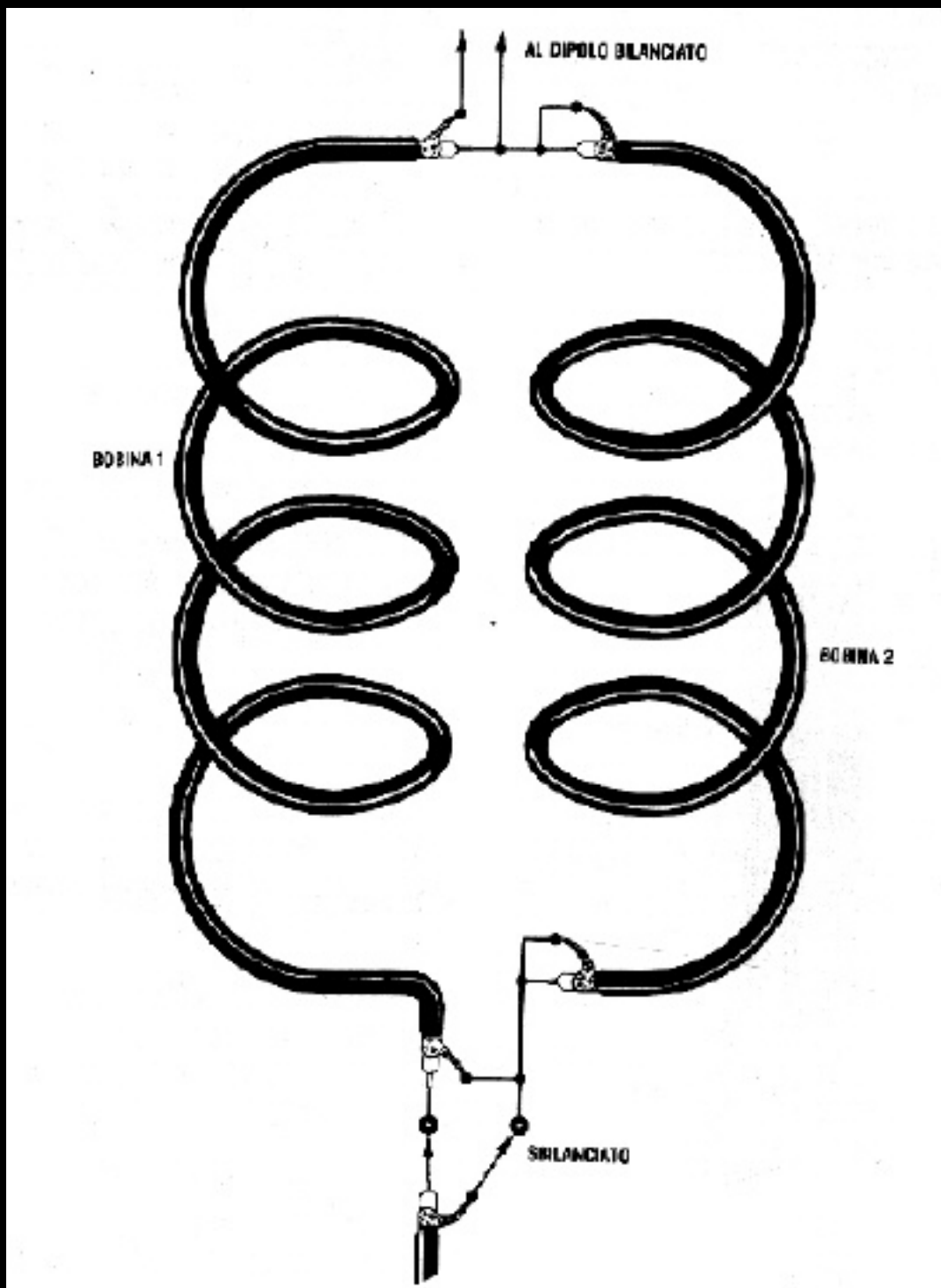

an other version of collins balun 1:1

[Back](#)

[GO TO HOME PAGE](#)

COLLINS BALUN 4:1

[Back](#)

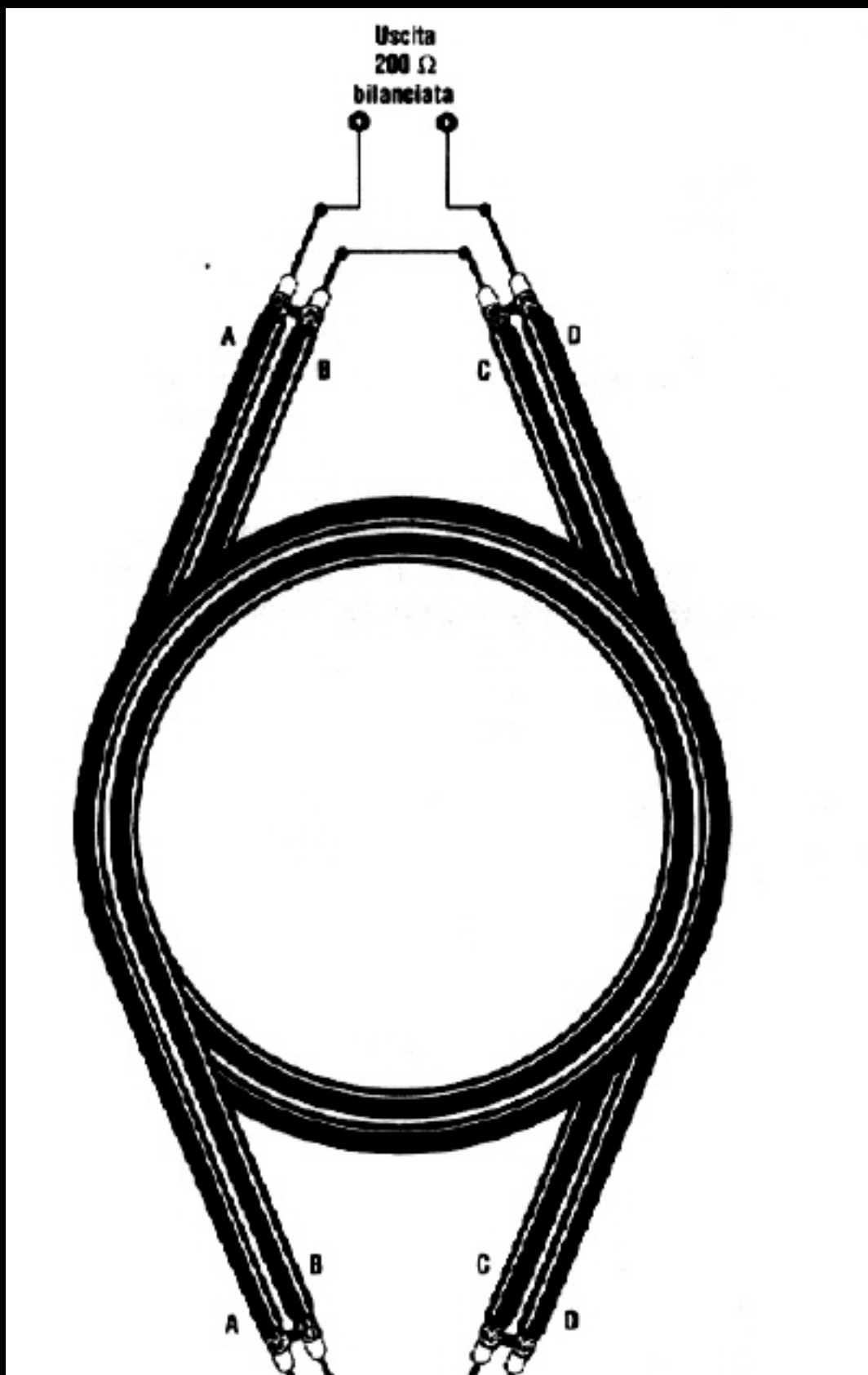

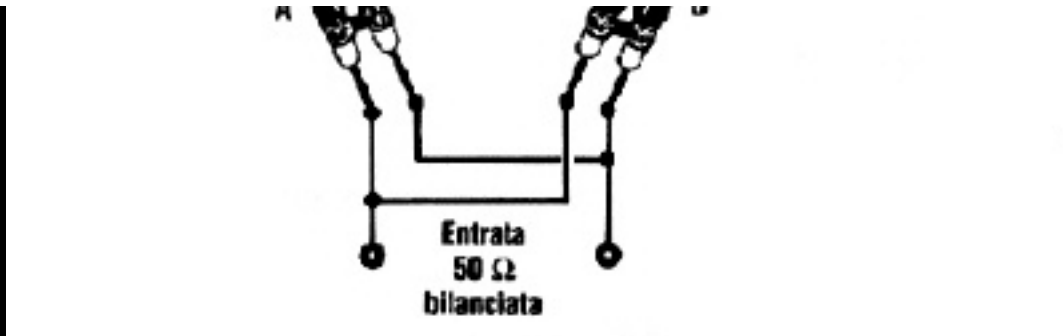

collins balun 4:1

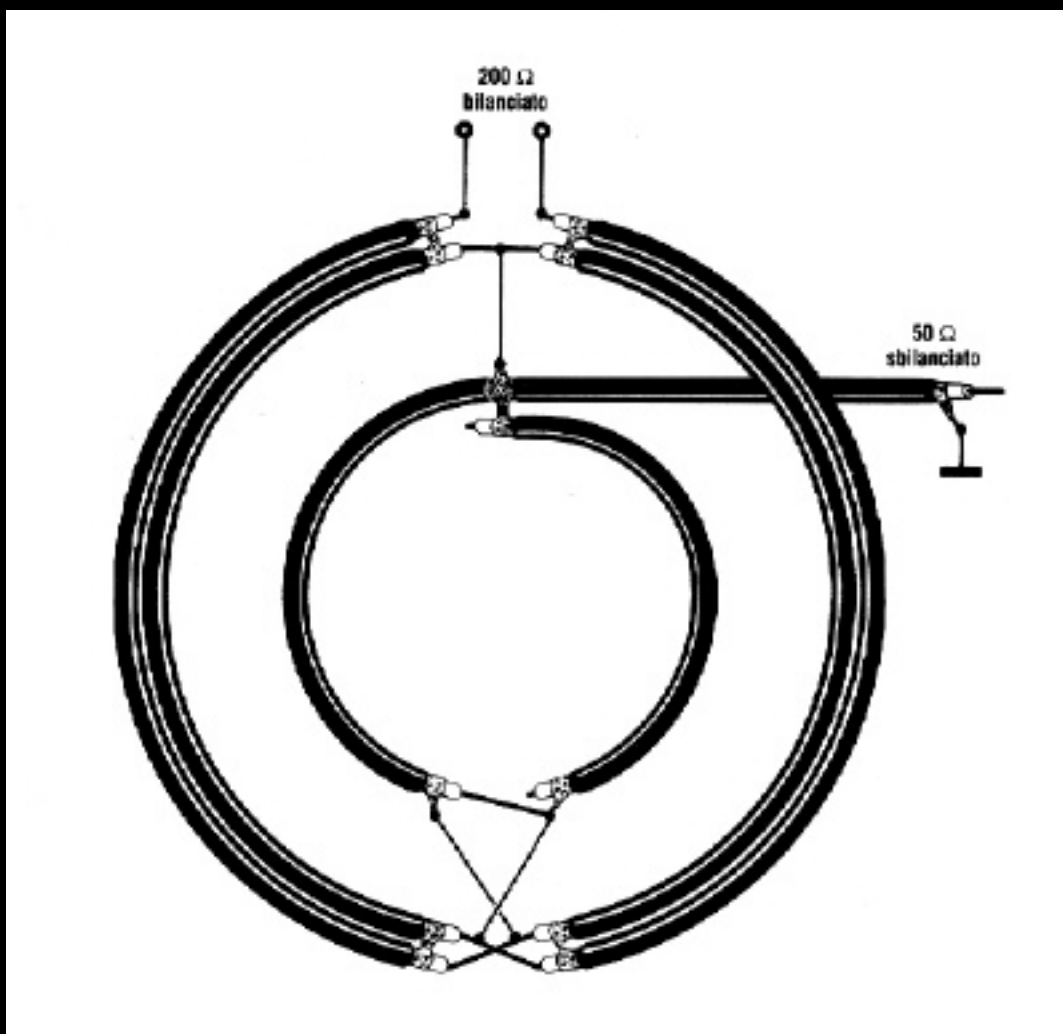

the same as above but with only 1 turn (just to understand schematic)

It's the same collins balun 1:1 followed by a balanced-balanced transformer with ratio 4:1;

the first part (the 1:1 balun) is made with 130+130 cm of coax cable (see collins balun 1:1 in the previous page); for the second part (the 4:1 transformer) use 4 x 130 cm of coax cable;

[Back](#)

[GO TO HOME PAGE](#)

BALUN 1:1

[Back](#)

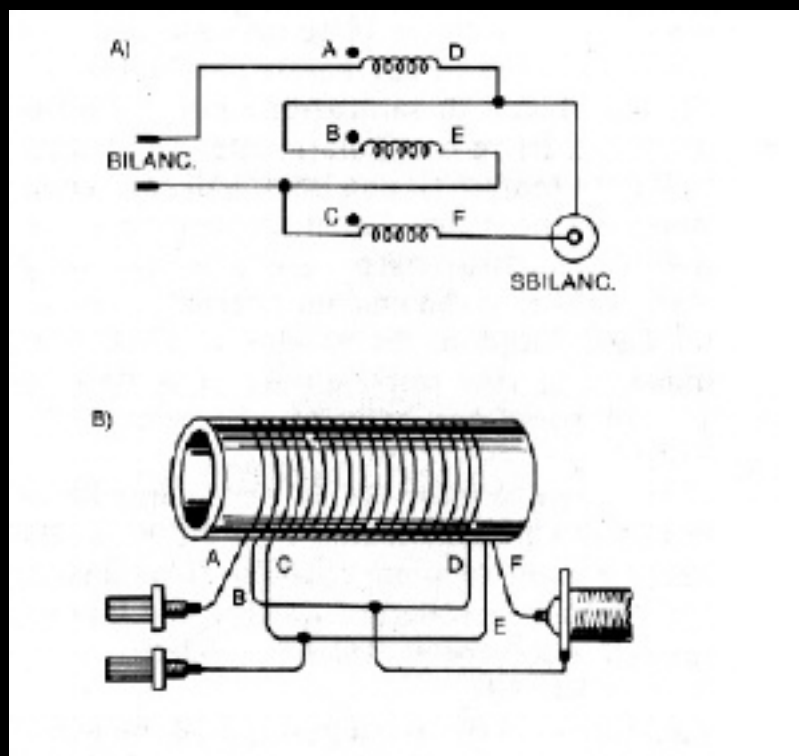

3 wire- 1:1 balun

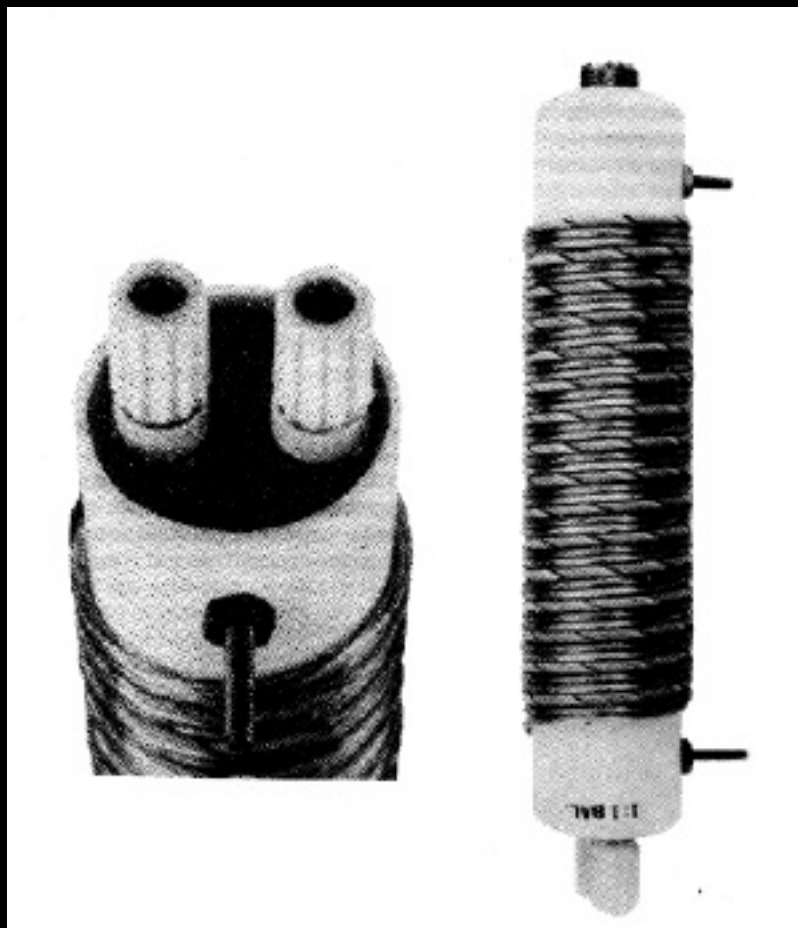

the same as above

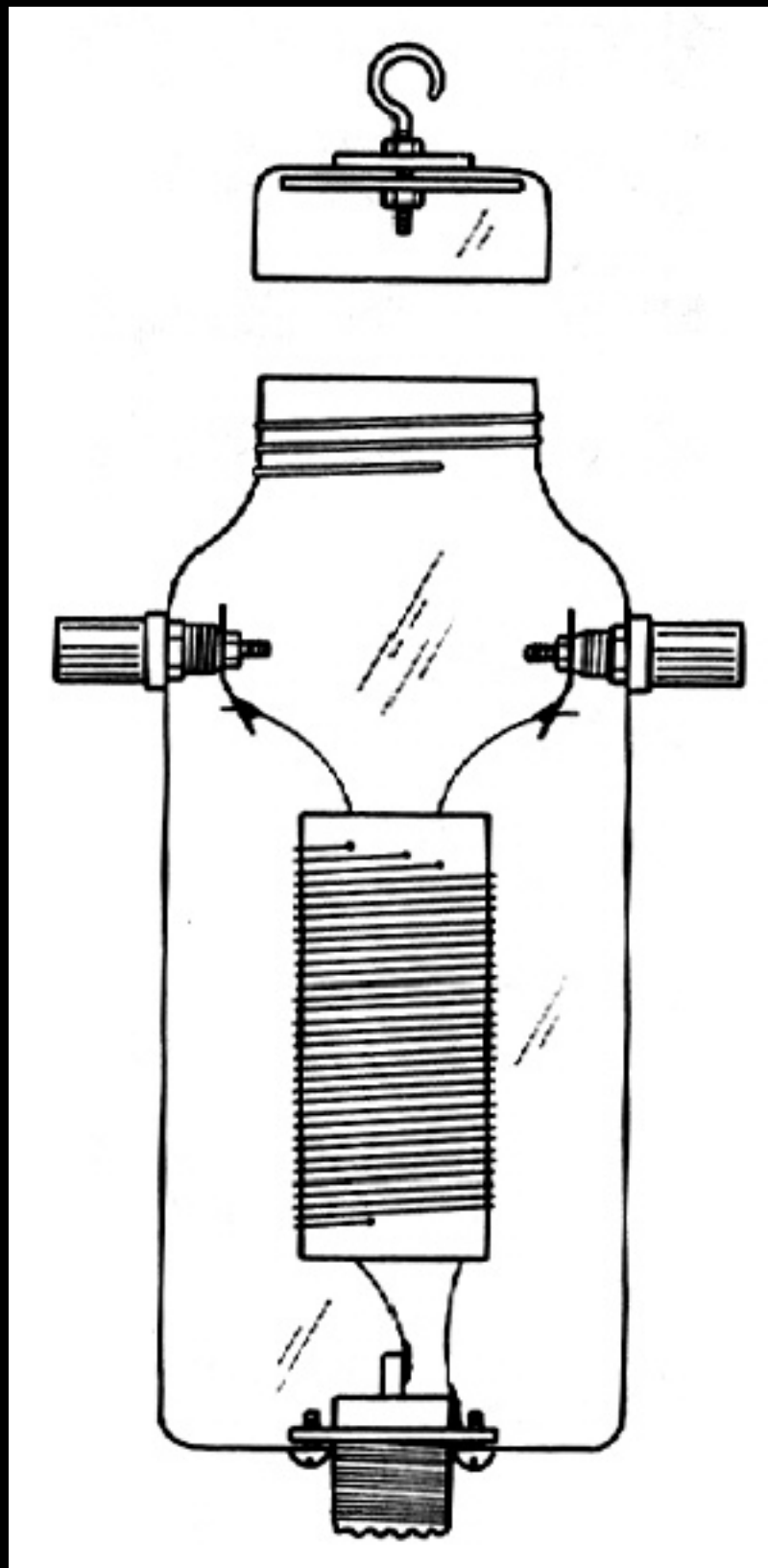

3 wire- 1:1 balun

[Back](#)

[GO TO HOME PAGE](#)

4:1 TRANSMISSION LINE BALUN

[Back](#)

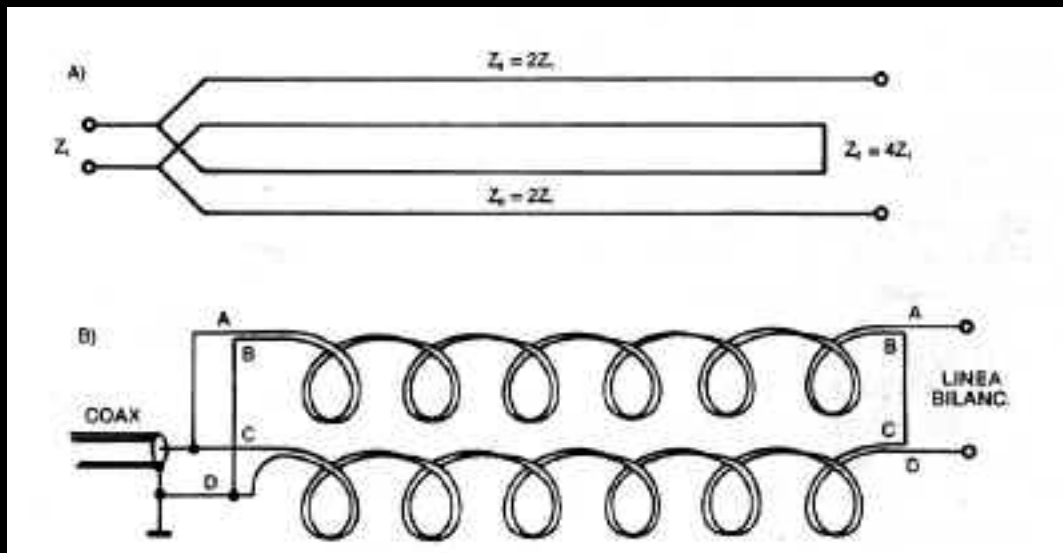

balun 4:1;

a): 2 transmission line

b): the same as above but turned around as a coil

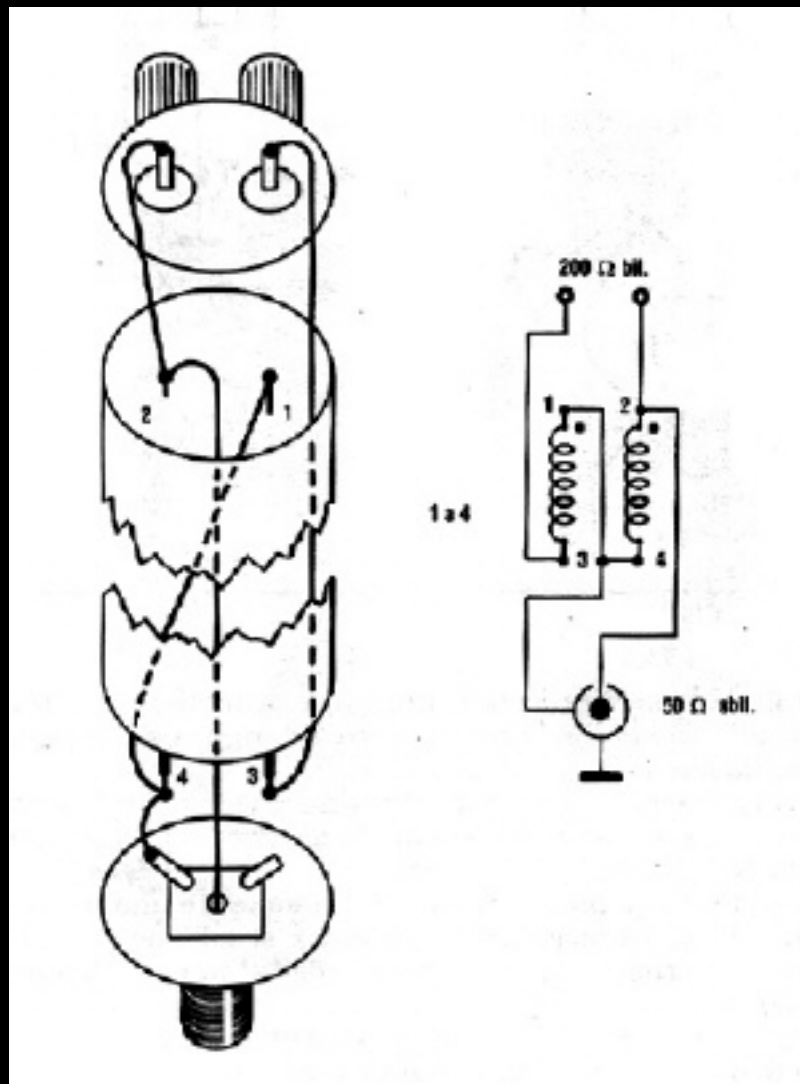

schematic of 4:1 balun

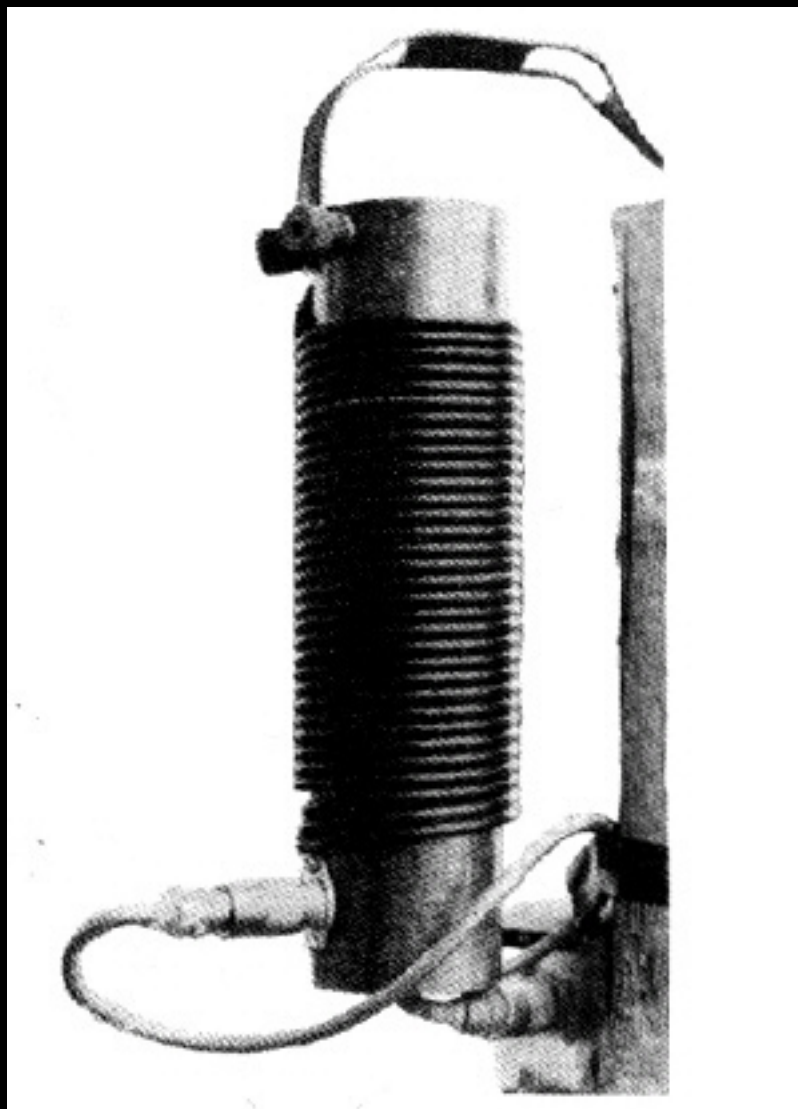

balun 4:1

[Back](#)

[GO TO HOME PAGE](#)

BALUN A LINEA DI TRASMISSIONE 6:1 E 9:1

[Back](#)

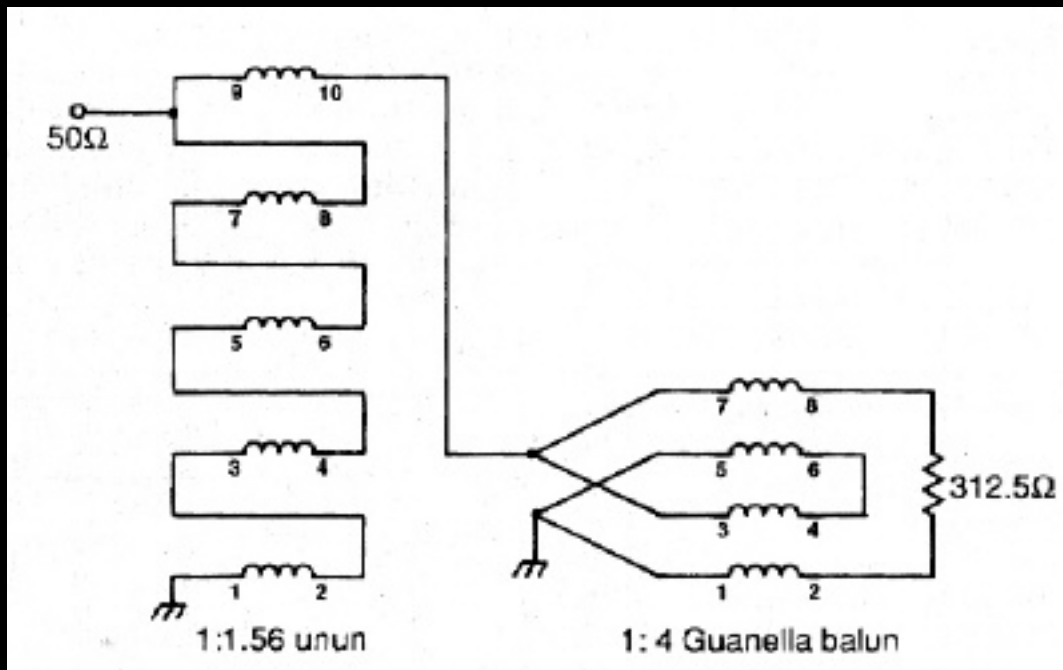

balun 6,25:1

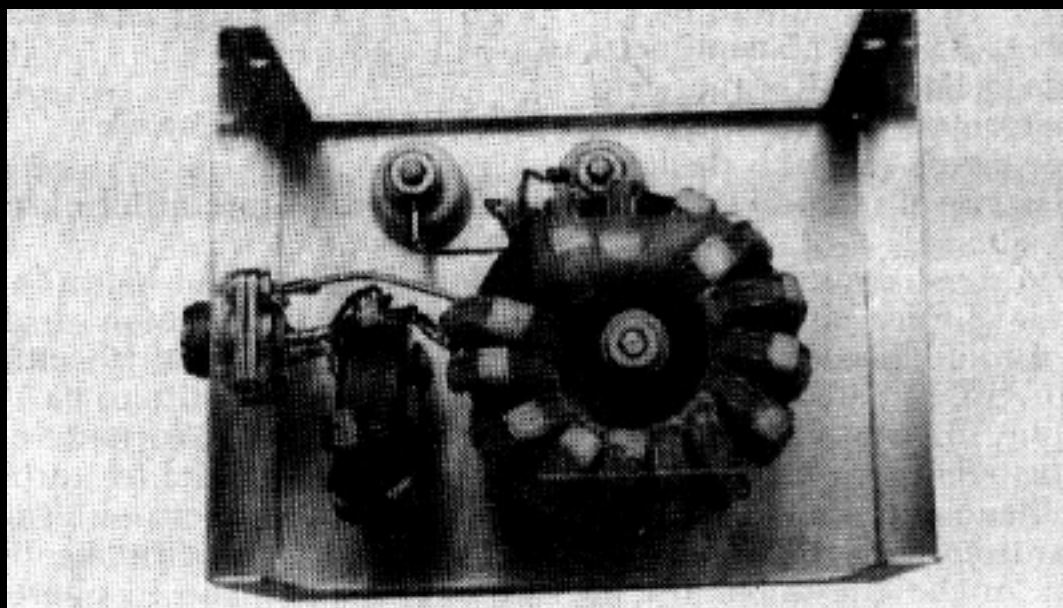

the same as above

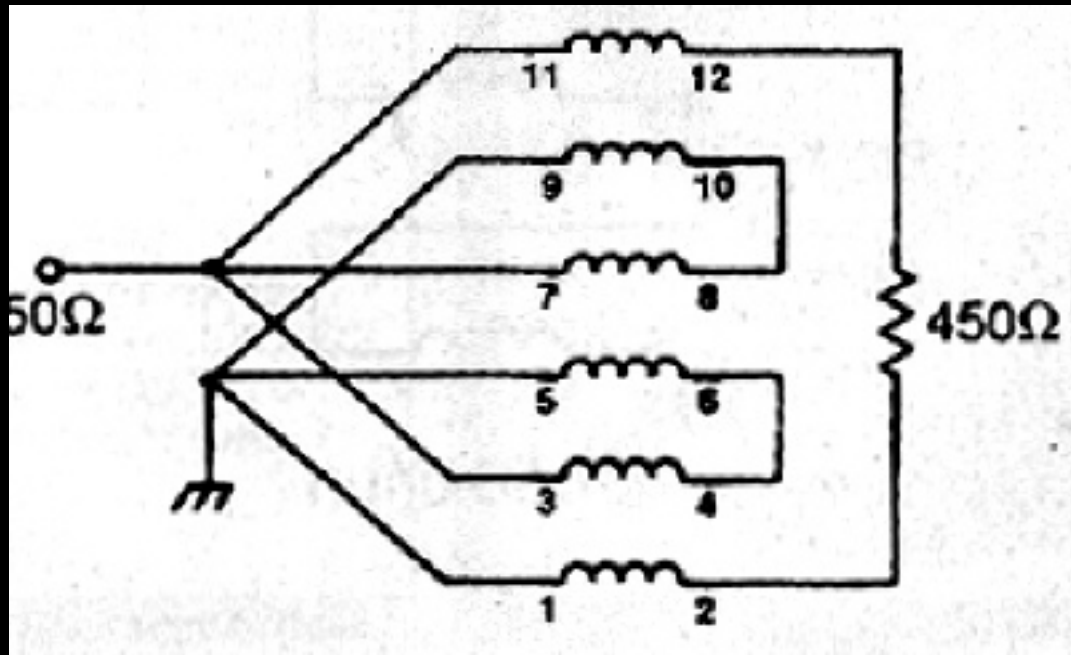

balun 9:1

[Back](#)

BAZOOKA BALUN 1:1

[Back](#)

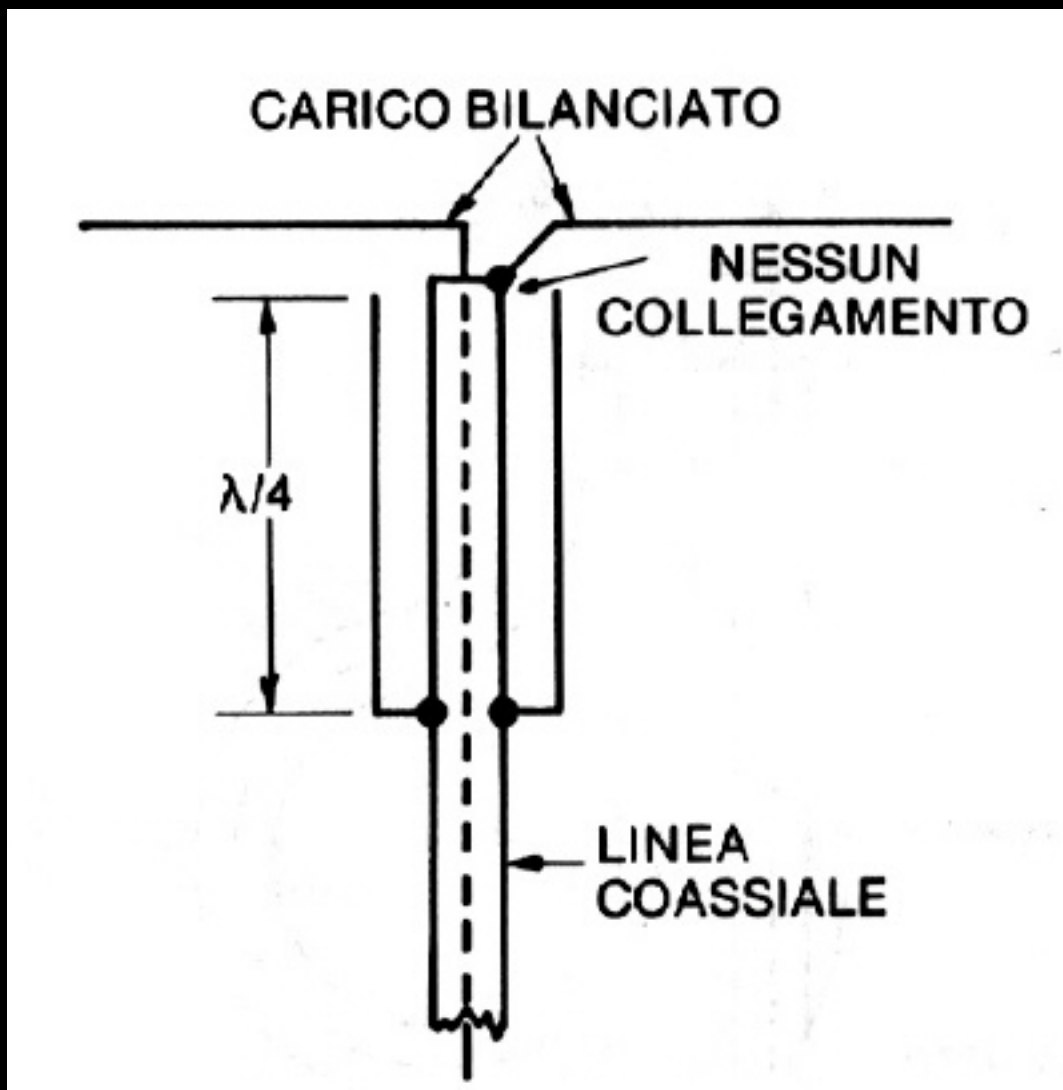

schematic of bazooka balun

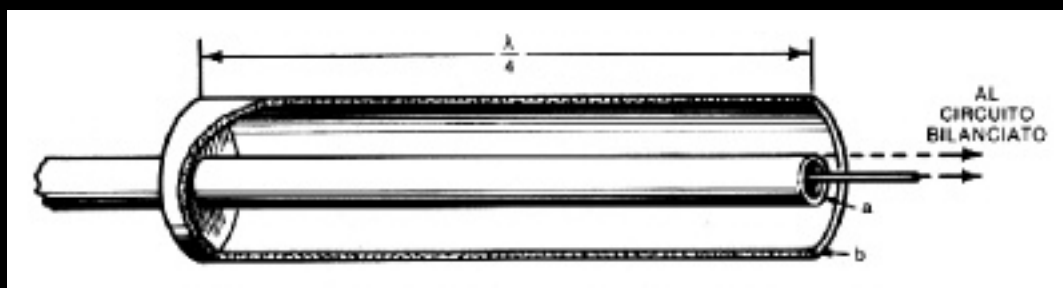

bazooka balun

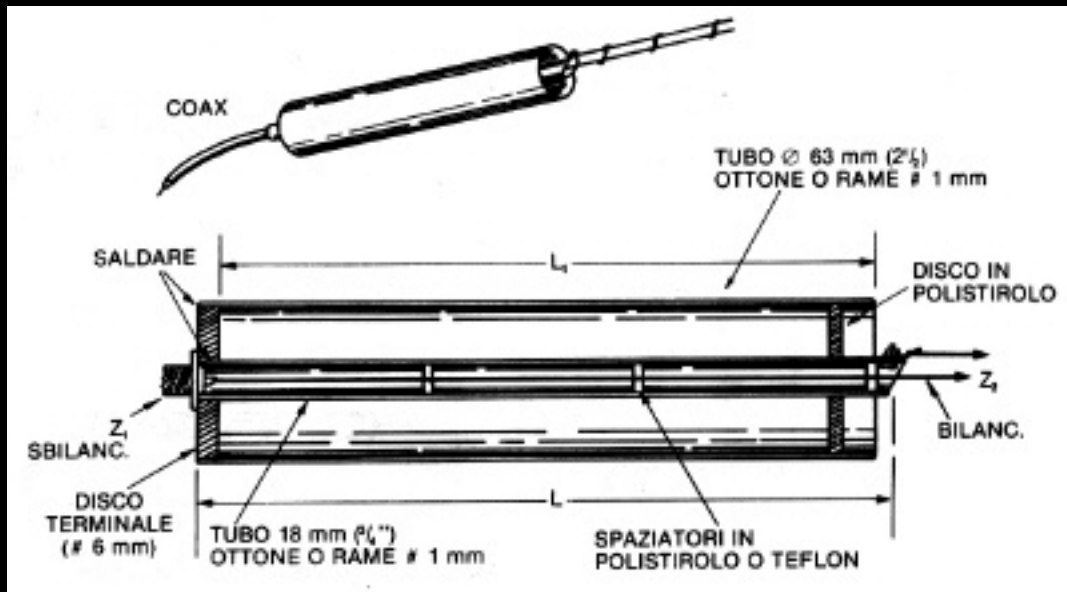

bazooka balun

[Back](#)

[GO TO HOME PAGE](#)

VHF BALUN 4:1

[Back](#)

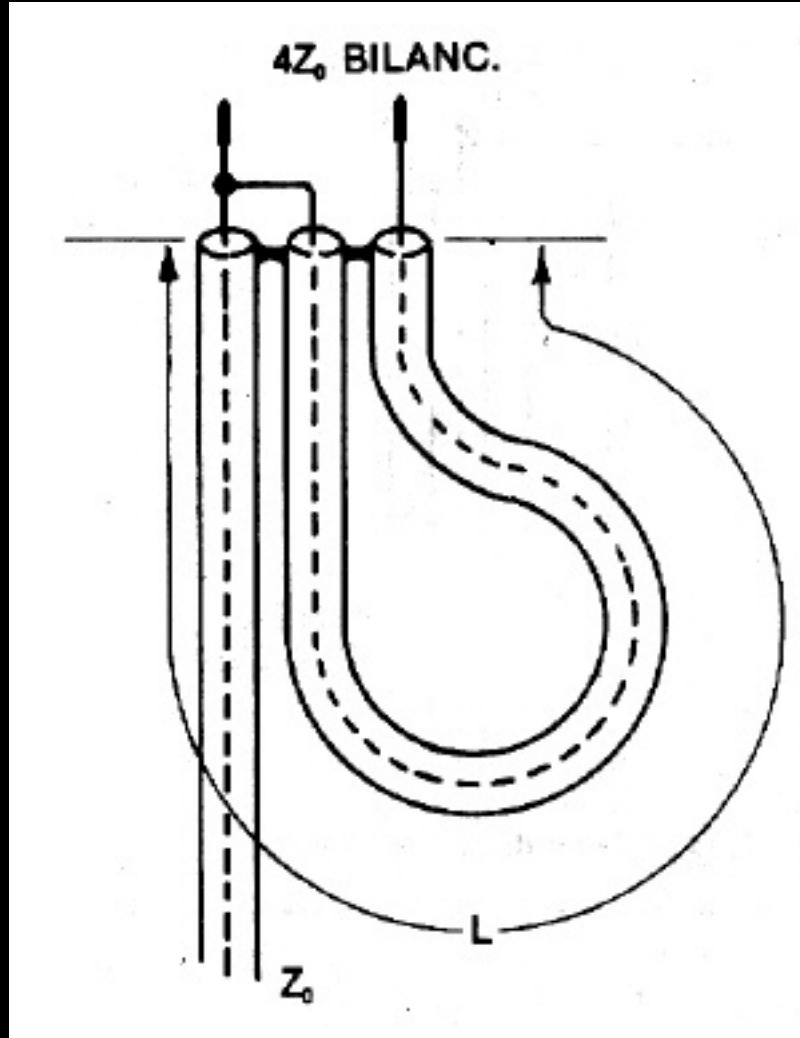

schematic of VHF balun 4:1

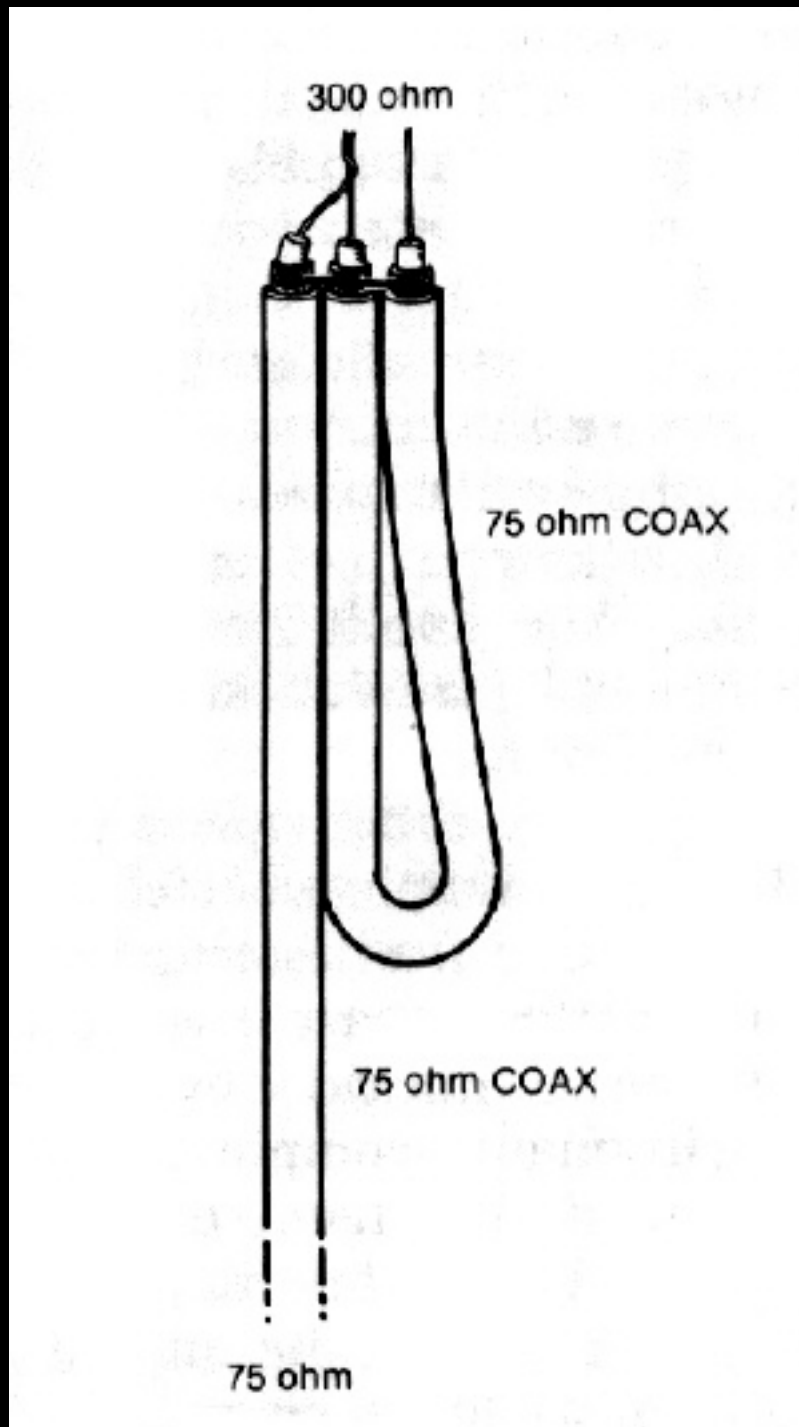

VHF balun 1:1

[Back](#)

[GO TO HOME PAGE](#)

BALUN ON FERRITE

[Back](#)

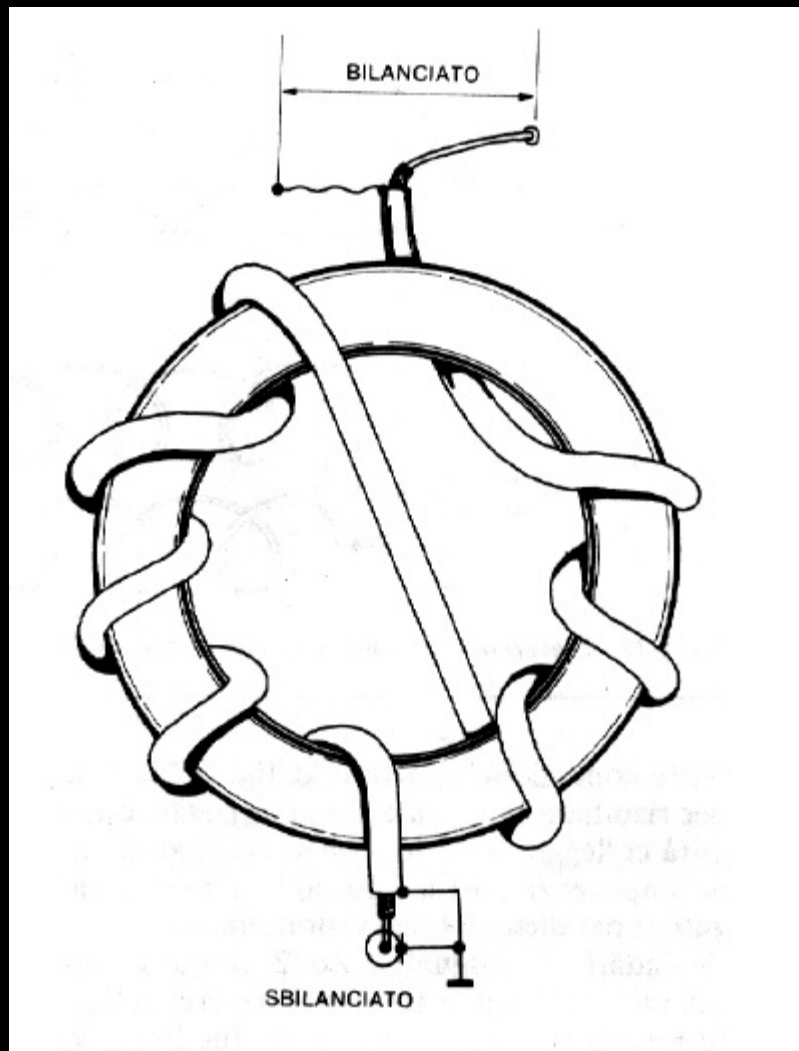

choke balun

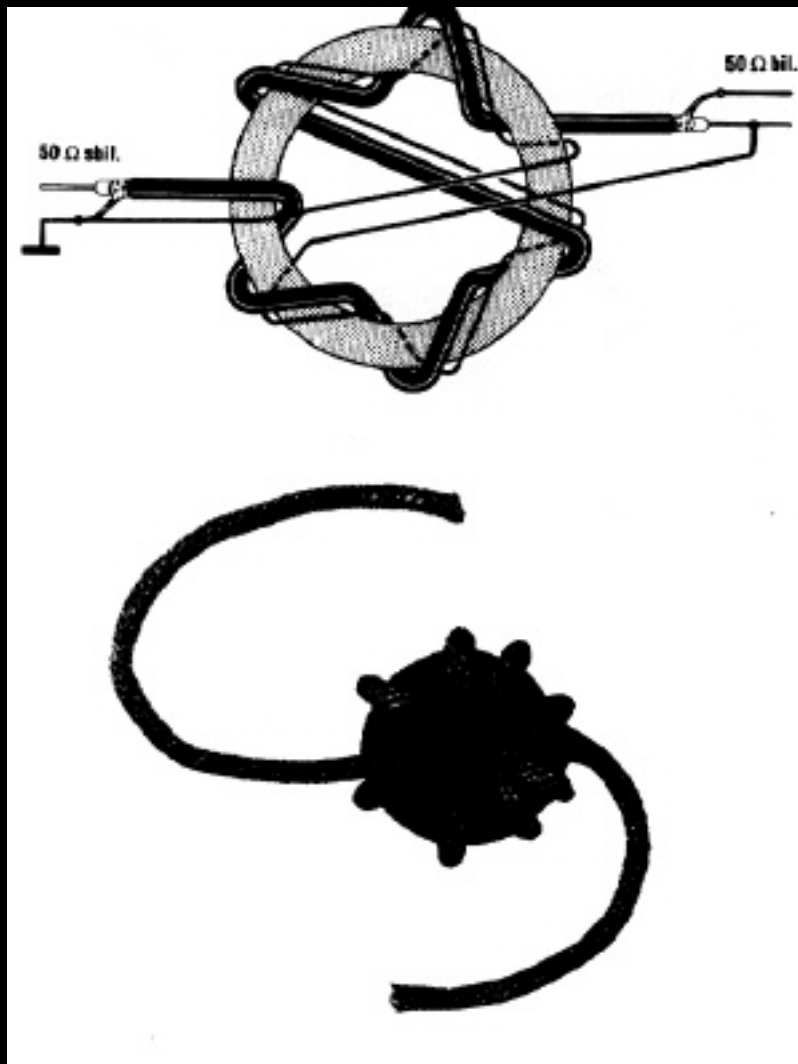

3 wire-1:1 balun

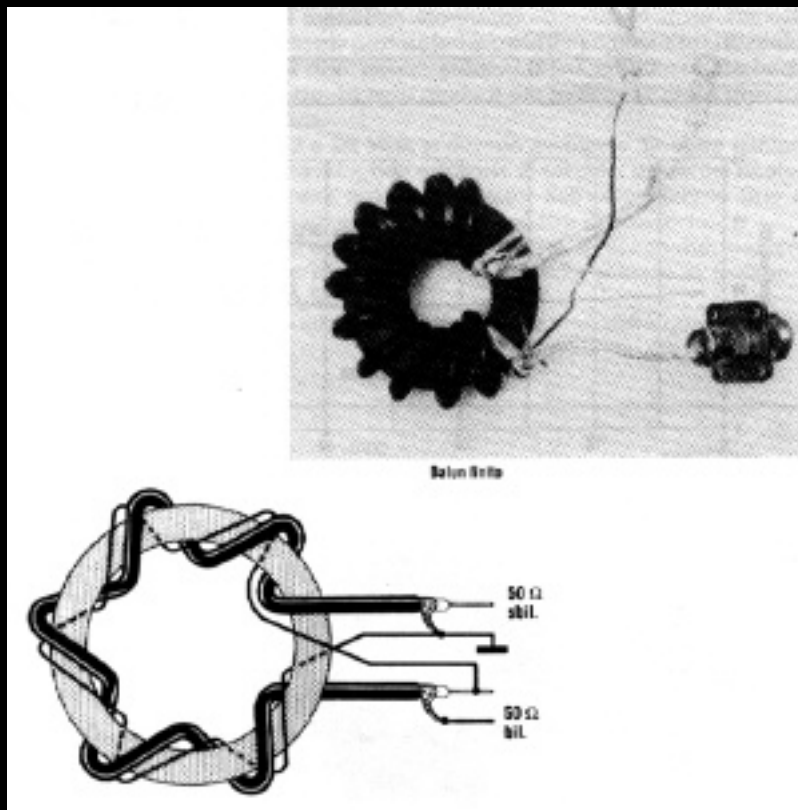

the same as above

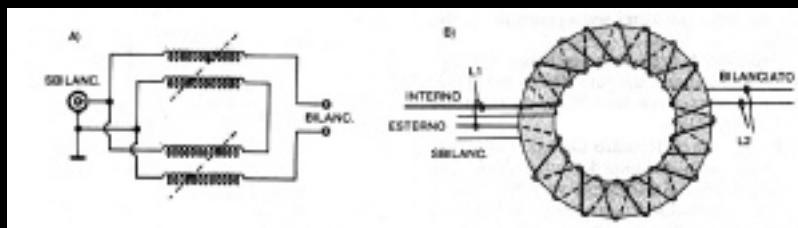

balun 1:1

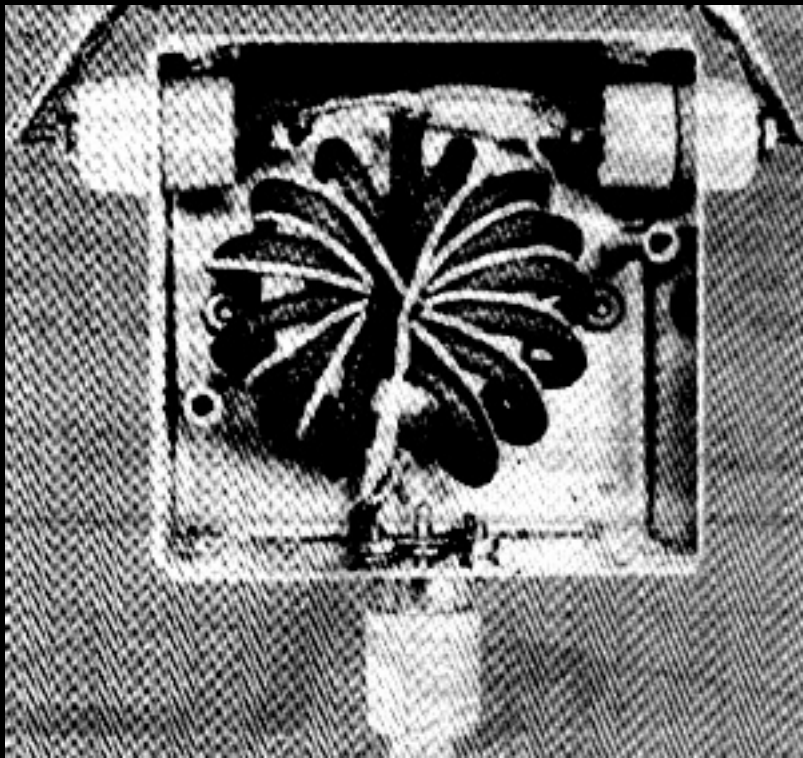

the same as above

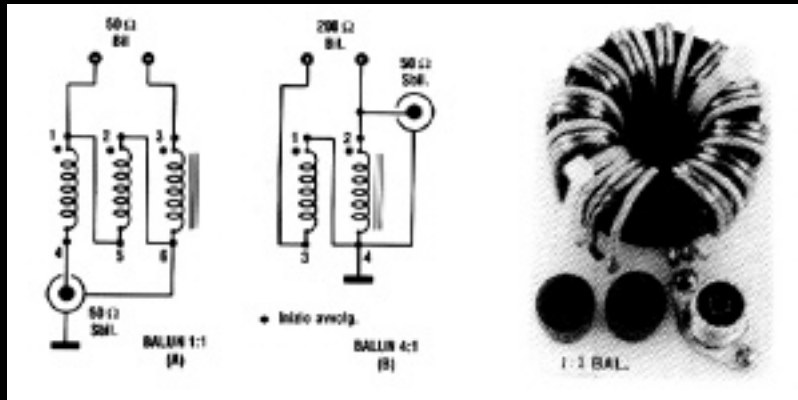

balun 1:1 and 4:1

[Back](#)

[GO TO HOME PAGE](#)

[Teory](#) [Practice](#) [My Balun](#)

MY BALUNS

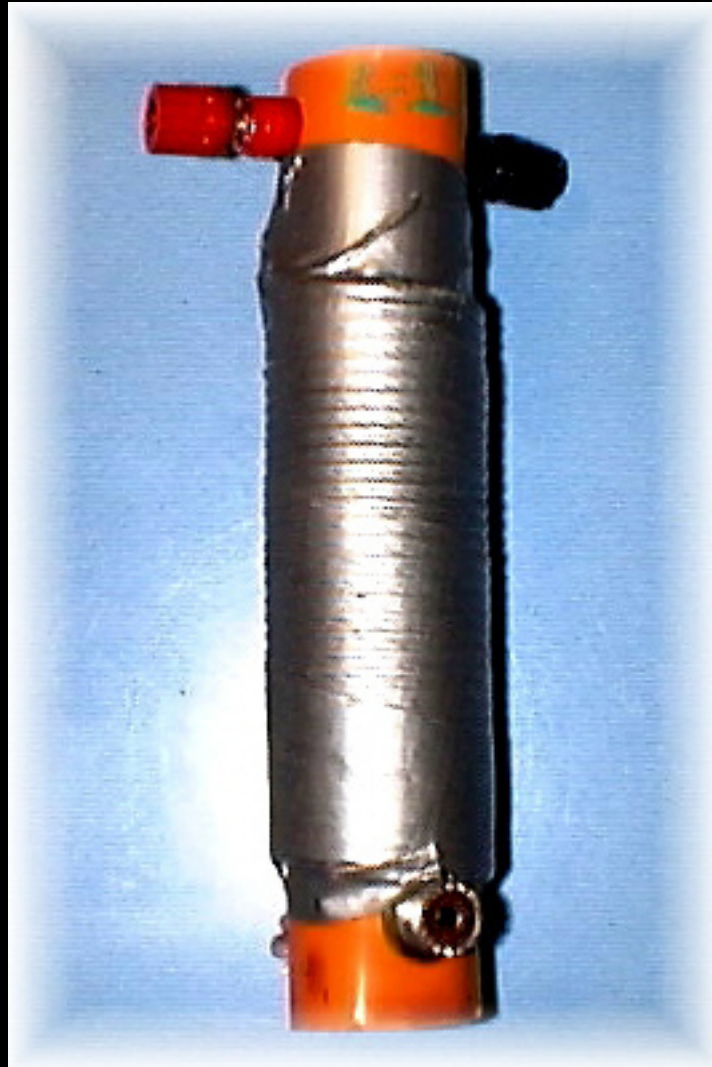

Usually I use a simple choke with antennas made with aluminium (it's usually free in the space) and a transmission line balun (with ratio 1:1 or 4:1) for wire antennas (it usually lower: V-inverted ecc.); just two word about that:

1. you can read that a balun is only a balanced-unbalanced adapter and NOT an impedance adapter but nobody says why; my opinion is the following: the first use of a balun is to adapt a balanced device to an unbalanced one (and avoid I3 flow on the shield of coaxial cable); if balun's ratio is other than 1:1 we have "also"(remember ALSO) an adaptation of impedance (of course if

the ratio is the right one); never use a balun only as impedance adapter; ie: if we have a 50 ohm coaxial cable (unbalanced) and a 200 hom antenna (unbalanced) we can NOT use a 4:1 balun: it's a nonsense.

2. Now I'll say you something about the use of a balun;

I built a V-inverted dipole (with coil to make it shorter) for 80 meters band and the top was at about 11 meters (so not very high and closed to objects); but there was no way to obtain a low S.W.R.: there was no a minimum S.W.R point; it was flat and high.

Than I built a 3-wire transmission line balun and...

here it is the S.W.R. curve with a 1:1 at centre band;

I just used a balun with the dipole at the same height; from that moment I have often moved my dipole, chanced the angle of the V-inverted: just shortening or lenghtening the dipole I have again my 1:1 S.W.R.

Well, now you can see my baluns; about tecnical data see the page "PRACTICE"; more, there're some photos.

[BALUN 1:1 transmission line used with 80 mt V-inverted dipole;](#)

[BALUN 1:1 transmission line used with 40 mt loop;](#)

[BALUN 1:1 choke used with 17 and 20 mt rotative dipole;](#)

[BALUN 1:1 ferrite used with 2 el. quad;](#)

[BALUN 4:1 transmission line used with 20 mt loop;](#)

73 de iz7ath, Talino

[GO TO HOME PAGE](#)

BALUN 1:1 TRANSMISSION LINE

[Back](#)

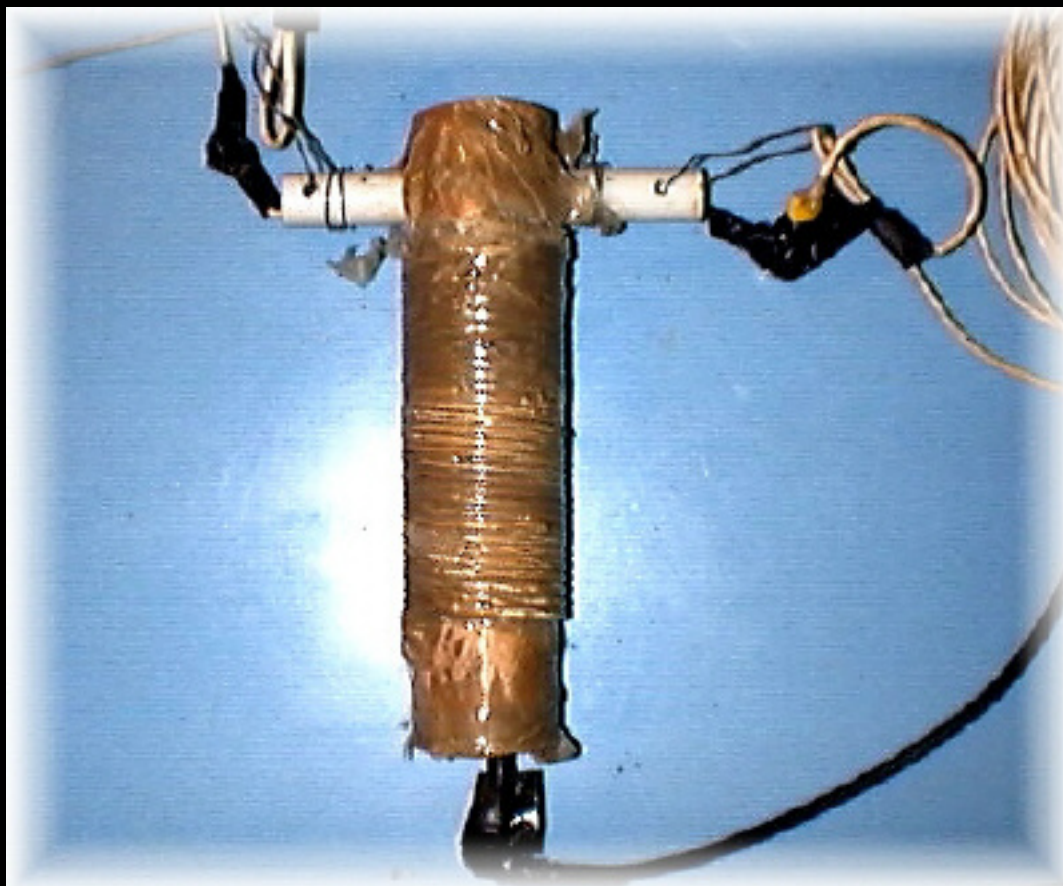

**It's one of my first homebrew balun, so....;
I have used :**

- **2 mm copper wire covered with PVC;**
- **Pink PVC pipe diam. 40 mm;**
- **PVS pipe diam. 16 mm;**

[Back](#)

[GO TO HOME PAGE](#)

BALUN 1:1 TRANSMISSION LINE

[Back](#)



**It's one of my first homebrew balun, so....;
I have used :**

- **2 mm copper wire covered with PVC;**
- **Pink PVC pipe diam. 40 mm;**

[Back](#)

[GO TO HOME PAGE](#)

BALUN 1:1 CHOKE

[Back](#)



In the photo it's near the rotator; it's just 7-8 turns of RG213 diam.15-25 cm;

[Back](#)

[GO TO HOME PAGE](#)

BALUN 1:1 FERRITE

[Back](#)



In the photo toroidal ferrite is under white PVC tape; I don't remember the type, but that's not important: use what you want (put it around the coaxial cable, not between shield and central cable).

[Back](#)

[GO TO HOME PAGE](#)

BALUN 4:1 TRANSMISSION LINE

[Back](#)

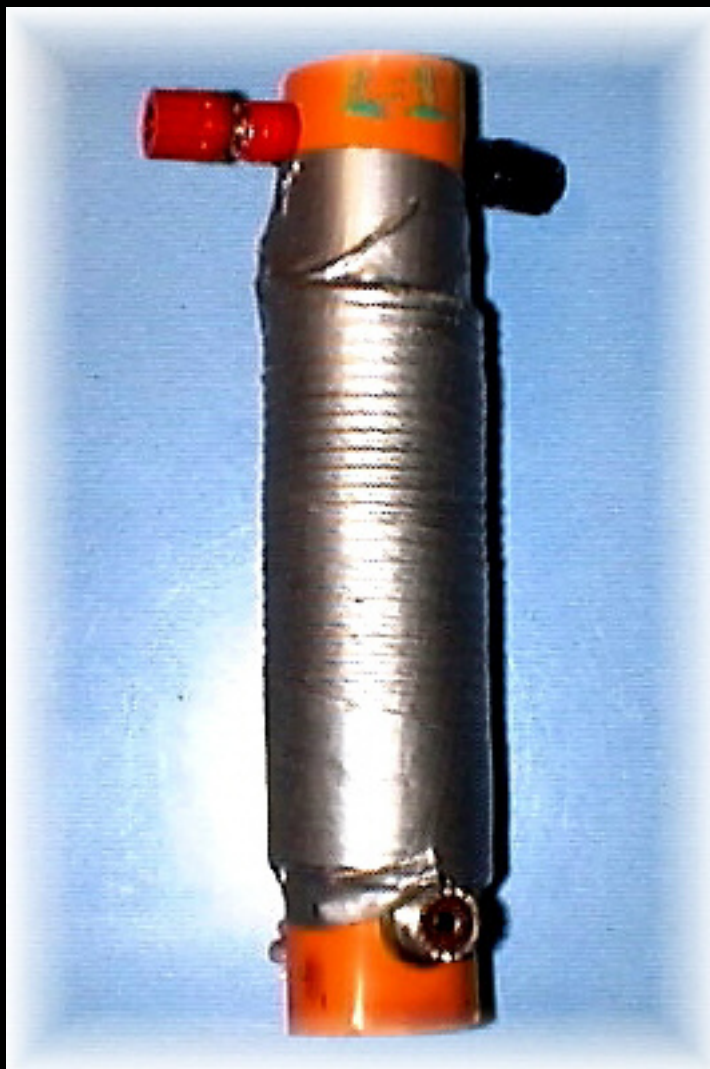

I have used

- Pink PVC pipe diam. 40 mm;
- 1 SO239;
- 2 jack used in power supply (black and white);

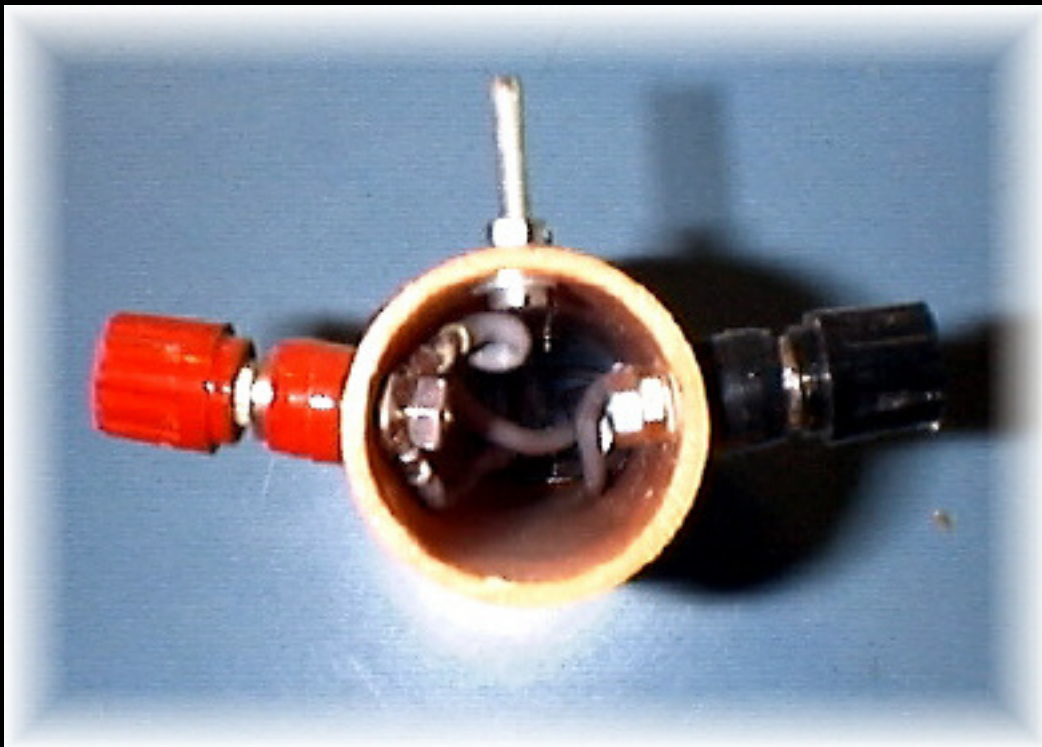

[Back](#)

Baluns

Index

-  [Balun Misconceptions](#)
-  [Proper Balun Design](#)
-  [Engineering and Building Baluns](#)
-  [Retrofit Balunstm](#)
-  [RemoteBaluntm](#)
-  [Feedline Isolation](#)
-  [The Effect of a Balun's Lead Length](#)
-  [Phase Delay Through Baluns](#)
-  [Power Rating](#)
-  [Balun Core Saturation](#)
-  [Installing Baluns](#)
-  [Weatherproofing](#)
-  [RFI Applications](#)

To return to the this point, simply use your browser's "Back" button.

The RADIO WORKS introduced a full line of precision, 'Current-type©' baluns beginning in 1986. We were actually producing 'Current-type©' baluns, in 1984, but it was not until 1986 that they became generally available to the public. They were instantly popular because 'Current-type©,' baluns avoid the bad habits that conventional 'Voltage-type' baluns exhibit.

'Voltage-type' baluns produce equal and opposite voltages at the balun's balanced port. Since low impedance antennas are current fed, a balun that produces equal and opposite currents at its output over a wide range of load impedances is desirable. There is little to be gained by forcing the voltages of the two antenna halves, whether the antenna is balanced or not, to be equal and opposite compared with the cold side of the balun input. The antenna field is proportional to the currents in the elements, not the voltages at the feed point.

Current-type baluns are not a new idea. They have been used in TV receivers for many, many years. TV tuners require a very wide bandwidth balun that will work with a severely

mismatched antenna, like a TV's so-called 'rabbit ears' antenna. The Current-type balun was the best choice for that application.

Unfortunately, when baluns were first popularized for use with wire antennas, a voltage-type design was chosen. Other balun makers just followed along. It was years before the first true, Current-type baluns appeared on the market.

Of course, times change and today you can find entire books devoted to Current-type baluns. The Radio Works was the first to offer you a full line of Current-type baluns for every application.

(This text was taken from the RADIO WORKS' Reference Catalog, copyright 1992, page 11.)

Misconceptions

1. Baluns will not improve SWR (the exception is where a balun used as part of a matching network, i.e., 4:1 baluns used in loops)
2. They are not Lightning arresters. The winding inductance in most baluns is far too low.
3. Also, built-in Spark gaps don't work. The radio equipment is destroyed long before the 'gap' arcs over.

4. Baluns do not allow multiband operation of single band, coax fed, antennas
They do

not make antennas more broadbanded.

These are all generalizations and, of course, there may be specific exceptions to any of them.

A balun really has only two jobs.

1. Isolate transmission line
2. Provide balanced output current

Proper Balun Design:

A properly engineered balun will include these design points:

1. High winding inductance (reactance)
2. Low stray capacitance
3. Very short internal transmission lines-

<< 1/4 wave, the shorter the better

4 High power components- High voltage wire & insulation to withstand high power or a mismatch.

5. Large wire gauge reduces I^2R losses.

6. Large cores - prevents saturation and provide the necessary high inductive reactance values on the low bands.

7. Mechanical considerations: Weather- proofing, rustproof hardware and a strong case to withstand loads.

Baluns

To insure long life, each RADIO WORKS balun is filled with a potting compound. In some models, this is an expansive foam, while in others, a solid plastic potting compound is used.

Balun cases are high quality, heavy-wall, PVC. Eye-bolts, if they are used, are made of stainless- steel. Wires from the internal windings of the *B1*, *B4*, *B75*, *Y1*, and *RemoteBaluns* are brought directly outside the case for connection to the antenna. This eliminates any chance of an unreliable connection.

In most models, the all-important wire used to make the internal transmission line(s) is insulated with Teflon® or similar materials. Top of the line models use silver-plated wire and Teflon® insulation for maximum power handling and minimum power loss.

All 1:1 and some 4:1 models are Current-type© designs. Current-type© baluns are extraordinarily saturation resistant and provide superior reactance characteristics. Signal distortion and RFI, due to core overload is practically eliminated. Current-type© baluns are very forgiving when feeding antennas that do not provide an ideal load.

Retrofit models

Installing a *Y1-5K*, *4K-LI* or *T-4* can substantially improve antenna performance by providing the antenna with balanced current and excellent feedline isolation. Adding a *Y1-5K* retrofit Current-balun©, a *4K-LI* or *T-4* to any antenna can significantly reduce feedline radiation, and dramatically decrease RFI and TVI. Beam antennas benefit from improved balanced drive and superior feedline isolation. An improved radiation pattern is the result. Also, receiver noise may be reduced by eliminating signal pickup by the

feedline

Remote Balun

You can have the convenience of coaxial cable combined with the flexibility of open wire.

The *RemoteBaluntm* is a special, saturation resistant, Current-Type© balun capable of handling the legal power limit with loads of moderately high impedance.

Unlike other baluns, the *RemoteBalun* is designed specifically for antennas fed with open-wire, ladder line or twin-lead. The balun is located outside where it belongs. A short length of very low loss coaxial cable connects your transmatch to the *RemoteBalun*. This eliminates the complication of routing balanced feeders into the radio room.

RFI Applications

Current-type(c) baluns are especially effective in reducing RF current on outer surface of a coaxial cable's shield. This type balun has several exceptional features that are not present in other balun designs. For example, in RFI reduction, the most important factors are very high load isolation over a wide bandwidth, extremely low loss characteristics, and wide, low SWR bandwidth. See the section on RFI control devices in the General Catalog for further detail.

Feedline Isolation

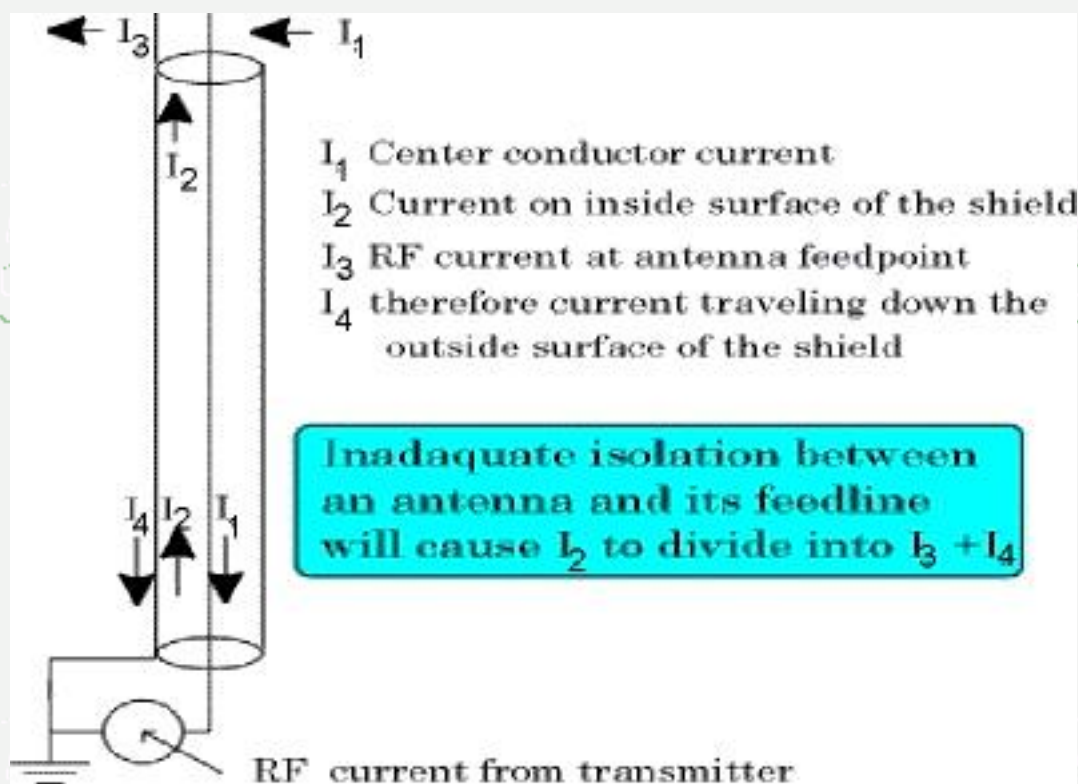

In this discussion there are four different RF currents flowing on or within a coaxial cable. There is an I_1 current flowing on the center conductor of the cable. Due to the skin-effect, there are two currents flowing on the cable's braided second conductor (its shield) which surrounds the inner conductor. On the inner surface of the braid, there is the I_2 current. At the antenna end of the coax I_2 divides into I_3 and I_4 . Without a device to isolate the antenna from the feed line, the outer surface of the coax's shield is part of the antenna, thus the division in current. I_3 is radiated by the antenna and I_4 flows along the coax. On its way back down the coax, some I_4 current is radiated, some is conducted back to the transmitter and on to station's ground system, house wiring, etc.

A balun or Line Isolator substantially reduces I_4 current. It has little or no effect on I_1 and I_2 currents. With I_4 reduced to nearly zero, $I_2 \gg I_3$. That means that nearly all of the I_2 current is radiated by the antenna, and none by the feed line. The antenna pattern improves and most of the RF current flowing down the outer surface of the coax's shield is eliminated.

The problem is to properly isolate the antenna from the transmission line. A current balun is the perfect device for the task, since we are working with equal RF currents at the feedpoint. Any of the RADIO WORKS' current-type baluns are perfect in this application. They all have excellent output balance and unmatched isolation factors. Line Isolators™ are designed to work with both balanced and unbalanced loads, but they are at their best when working with unbalanced loads.

Although a well designed current balun will eliminate I_4 current, there will be an induced current, call it I_{4i} (subscript "i" for induced) flowing along the outside of the coax's shield. This current is the result of the coax being the radiation field of the antennas. Obviously,

since the coax conducts the RF energy to the antenna it is not possible to physically isolate the coax from the effects of the antenna's radiation field. Consequently, it is advisable to install a Line Isolator at the transmitter end of the coax to eliminate the ground path for the RF current induced by the antenna's radiation field. The length of the coax will have some influence on the RF induced onto the coax.

You may notice that when you add a RADIO WORKS Current-type© balun to an existing antenna system, a dipole for example, the resonant frequency will move upwards a bit. When this happens, you know that the coax was acting as part of the antenna making it appear longer. The current balun isolated the coax from the antenna and the antenna is now operating closer to its formula frequency.

Experiencing this effect, leaves little doubt that the balun was needed and is useful even with dipoles and similar, simple antennas.

A flat SWR curve

Current or Voltage Baluns?

Most commercial baluns are voltage-types. As such, their performance is poor unless they are operated under ideal conditions. Even under the best of conditions, a perfect match, low power, etc. insufficient winding inductance and poorly designed transmission lines sacrifice efficiency and reduce bandwidth.

The B4-2KX balun is an excellent example. It is a high quality, high power, twin transformer 4:1 balun. Two special ferrite toroids to help manage reactance and provide the inductance values necessary in a 4:1 balun. The output impedance of the B4-2KX balun is 200 ohms. The inductive reactance of the internal windings must be at least 1000 ohms to effectively isolate your antenna from its transmission line. I have measured other commercial baluns where this value is only 240 ohms. This is a uselessly low value.

Here is another example: The transmission lines in many 1:1 and 4:1 baluns is #14 enamel covered wire. The impedance of such a transmission line (two wires in parallel) is generally between 20 and 25 ohms. This value is totally inappropriate. It should be 50 ohms if the balun is to be used with 50 ohm coax. Otherwise, bandwidth will suffer and unwanted reactance can be introduced into your antenna system. We use very carefully designed transmission lines. We use #14 wire and the spacing between the wires determines the line's impedance. This is carefully controlled to provide maximum bandwidth, power handling, and minimum effect on antenna tuning. Look at the diagram above. Here, our B4-2KX is compared with the most popular 4:1 balun on the market. Notice the narrow, low SWR bandwidth of the competitors balun and compare it with the nearly perfect curve of the B4-2KX.

Achieving this kind of result is difficult. It is difficult to produce the necessary inductance reactance on the low bands without introducing unacceptable capacitive reactance and

leakage on the upper bands. Broadband performance is possible only through the correct application of both selected ferrites and properly designed transmission lines and *L/C compensation networks*. The mechanical construction of the balun also influences the final characteristics of any balun.

Wire Lead Length and Tuning Effects

The length of a balun's output lead can have an effect on the tuning of your antenna. These leads are part of the antenna and in some applications, can make antenna resonance drop in frequency by a small amount. The effect is greatest on 10 meters where the length of the balun output leads are the longest in terms of antenna length. On 80 meters there should be no noticeable effect.

The Yagi Baluns have precisely measures leads. Occasionally you should take the extra lead length into account. Most of the time, an inch or two, will make little difference if Gamma or Beta matching schemes are used. The same can be said of most simple antennas.

Phase Delay

All RADIO WORKS Line Isolatorstm have a specified delay time through Line Isolators. This value is unimportant unless the Line Isolators are used in matching sections, phasing line or similar applications.

If the length of the transmission line or matching stub is critical, use the phase delay figure in the specifications to compensate for the addition of the Line IsolatorsTM to the system.

For example, the C75-4K Line IsolatorsTM has a phase delay at 3.5 MHz of 2.90. Double the frequency and you double the delay. To find the delay at a specific frequency, use the formula at right. Sometimes the phase delay is important. Here is a simple example.

Suppose you are building a full-wave loop antenna for 7.2 MHZ. You plan to use a 75 ohm quarter-wave matching stub (commonly known as a Q-section) to match the loops' 120 ohm impedance to 50 ohms.

The formula for the matching stub is

A quarter-wave stub for 7.2 MHZ using a solid dielectric coax with a velocity factor .66 is

To compensate for the installation of a C75-4K Line IsolatorsTM, the stub will have to be shortened slightly long due to the phase delay of the Line Isolatorstm. The phase delay of a C75-4K is 5.960 @ 7.2 MHZ. The calculated quarter-wave stub length @ 7.2 MHZ is 22.5'. We should shorten the coax part of the matching stub by 5.960 if we want optimum

results. To find the length, follow this formula.

Shorten the coaxial stub by 1.45 feet (1.5' when rounded off)

Subtracting 1.5 feet from the 22.5 foot stub yields 21.0 feet. Add the Line Isolators™ and the stub is again 90°.

Phase delay exists in all baluns and similar devices. We give you the numbers to take advantage of it.

Power Rating

All products made by the RADIO WORKS will handle the legal power limit, unless it is specifically designed for low power or receiving applications. Since The RADIO WORKS advocates adherence to the legal power limit, I do not like to rate components above that level. However, since 2:1 and 3:1 safety factors are often desirable, the RADIO WORKS does build heavy duty components.

Rated power assumes an SWR of less than 2:1 unless otherwise noted. The rated frequency is 3.5 MHz. Duty-cycle is CW or SSB with normal processing. High duty cycle modes, like RTTY, may over stress a balun and require improvement in load matching, lowering the power, or switching to a higher rated balun.

Saturation

When a ferrite core balun saturates, you will notice an upward drift in SWR long before the balun fails. Core saturation can be caused by too great a mismatch at the load (antenna) or by running too much power or a combination of both. If you see an upward movement in SWR, locate the problem immediately. If you must stay on the air, lower power until SWR drift ceases.

In new installations, tune the antenna system for minimum SWR. Apply a few hundred watts of power on each band the system covers. Monitor the SWR with power applied. Do not exceed the time limits of your amplifier. Increase power gradually until maximum power output is achieved. Watch the SWR or reflected power meter closely. If the SWR drifts upward, locate the problem before continuing operation.

RemoteBaluns™

RemoteBaluns are a special case. They operate under the most difficult conditions. The checkout procedure for the RemoteBaluns™ is the same as in the previous paragraph. If you notice the SWR drift on one or two bands, this usually means that the load impedance is too high or too low for efficient balun operation. Changing the length of the balanced

feeders (ladder line) by a few feet or ideally, 1/4 wavelength, will often remedy the situation and permit full power operation.

Installation

While there are no special mounting requirements, I do suggest strain relief for long unsupported transmission lines. Use standoffs for your coaxial cable. This can improve the front-to-back and front-to-side ratios of your beam antenna. It doesn't make sense to put up a good beam and then let the feed line radiate (because of a poor balun). It also doesn't do your antenna system any good to couple your coaxial cable to a large vertical antenna (like your tower). Taping your coaxial cable to a tower leg creates a large capacitor which effectively couples your beam and vertical antenna (tower) together. Use stand-offs to hold the coaxial cable away from the tower leg. This procedure in combination with a RADIO WORKS balun can dramatically improve the front-to-side ratio of some beams.

There are no special mounting requirements. The unit may be supported by the eye-bolt or strapped to the antenna's boom and secured with waterproof tape or quality hose-clamps.

Lightning Protection

Some balun manufacturers will tell you that their baluns have built in lightning protection. Those that do, use spark gaps which are absolutely useless. The high winding inductance of our baluns offers some protection, but for proper protection, use devices intended specifically for "surge" protection.

Weatherproofing

Each RADIO WORKS balun is either potted in solid plastic or expansive foam. All critical components are completely protected even if water enters the balun's case.

Moisture can enter the balun case only through the holes where the wires emanate. You can completely seal your balun by putting a small amount of CoaxSeal around wires leaving the case. Press the CoaxSeal firmly around the wire and against the case. Make sure the coax seal 'wets' (or sticks) to both the wire and the case. This will insure a weather tight seal. Always protect all coaxial connectors with CoaxSeal.

Seal all electrical components and coaxial connectors exposed to the weather.

Use CoaxSeal(r) to wrap any connector that is exposed to the weather. Generously wrap each connector and mold the layers together with your fingers to insure a solid, impenetrable seal.

Balun Index



Jim's Notebook Index

NOTES

Refer

RADIO WORKS
Reference

Refer

RADIO WORKS
Reference

Refer

RADIO WORKS
Reference

Refer